

1 RoHS Compliance

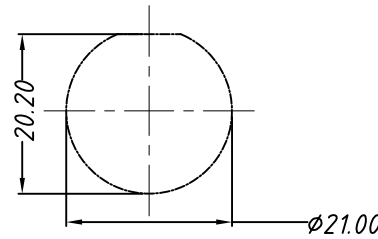
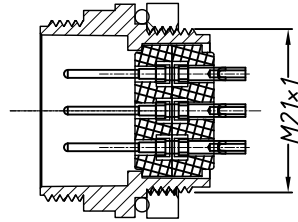
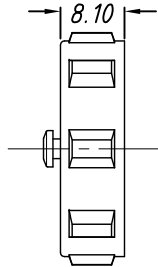
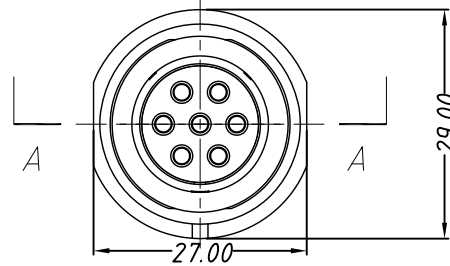
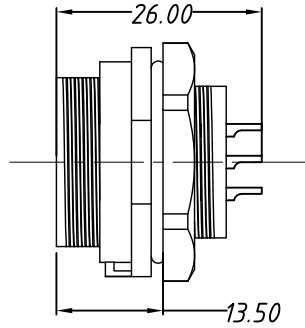
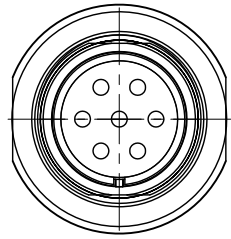

SECTION A-A

PANEL CUT-OUT  
Thickness 3.0mm Max

Material & SPEC.

- 1.Shell Material: PPO,PA66 UL94V-0
- 2.Insulation Materials: PPS, High Temperature 260°C
- 3.Contact: Brass,Gold-plated
- 4.Insulation resistance: 2000MΩ
- 5.Number of poles: 2~12 poles
- 6.Coupling: Threaded
- 7.Termination: Solder
- 8.IP Rating: IP68
- 9.Durability: 500 mating cycles
- 10.Temperature Range: -25°C~+80°C

ORDER INFORMATION:

L - KLS15 - W21 B2 - XX

RoHS  
IP68 Connector type  
Male Socket for Panel Mount  
Number of poles: 2~12 poles

Solder contact arrangement and spec

Number of contact	2	3	4	5A	5B	5C	7	9	12
Male contact face view									
Rated current (A)	30A	30A	30A	30A	30A/5A	15A	15A	5A	5A
Contact Diameter	φ2.8×2	φ2.8×3	φ2.8×4	φ2.8×5	φ2.8×2 φ1.0×3	φ1.8×5	φ1.8×7	φ1.0×9	φ1.0×12
Rated voltage (AC.V)	500V	500V	500V	500V	500V	500V	500V	500V	400V
Test voltage (AC.V) 1min	1500V	1500V	1500V	1500V	1500V	1500V	1500V	1500V	1200V
Contact resistance mΩ	1	1	1	1	5, 1	2.5	2.5	5	5
Wire size solder mm <sup>2</sup> /AWG	≤4.17/11	≤4.17/11	≤4.17/11	≤4.17/11	≤4.17/11 ≤0.785/18	≤2/14	≤2/14	≤0.785/18	≤0.785/18

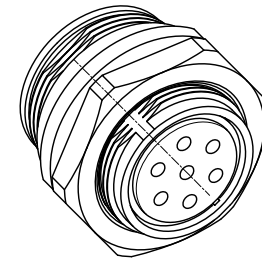

Match Connector

KLS15-W21B1

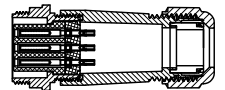

GENERAL TOLERANCE		PROJECTION	Description:
.X	±0.05	UNITS	mm
.XX	±0.02	SHEET SIZE	A4
		KLS P/N:	KLS15-W21B2-XX
Draw:	Daniel	2018-08-27	NingBo KLS ELECTRONIC CO.,L TD.
Check:	Daniel	2018-08-27	
SCALE	1:1	SHEET	