

1
RoHS Compliance

Material & SPEC.

- 1.Shell Material: PPO,PA66 UL94V-0
- 2.Insulation Materials: PPS, High Temperature 260°C
- 3.Contact: Brass,Gold-plated
- 4.Insulation resistance: 2000MΩ
- 5.Number of poles: 2~9 poles
- 6.Coupling: Threaded
- 7.Termination: Solder
- 8.Cable outer Diameter: 6~10mm
- 9.IP Rating: IP68
- 10.Durability: 500 mating cycles
- 11.Temperature Range: -25°C~+80°C

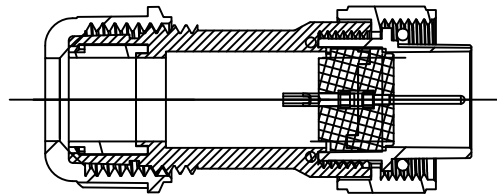
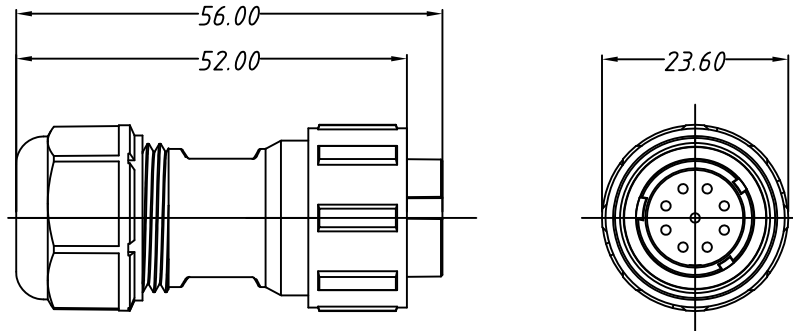
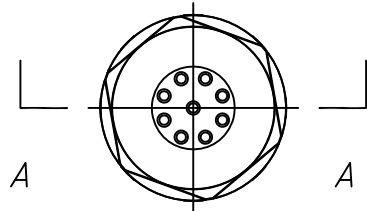
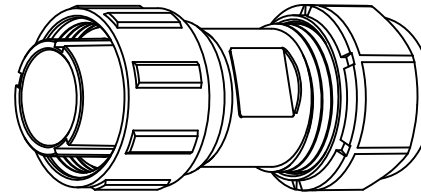

SECTION A-A

ORDER INFORMATION:

L-KLS15-W17 A1-XX

- RoHS
- IP68 Connector type
- Male Plug for cable
- Number of poles: 2~9 poles

Match Connector

KLS15-W17A2

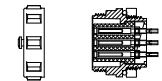

KLS15-W17A3

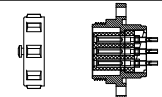

KLS15-W17A4

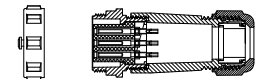

Solder contact arrangement and spec

Number of contact	2	3	4	5	7	9
Male contact face view						
Rated current (A)	10A	10A	5A	5A	5A	5
Contact diameter	φ1.5×2	φ1.5×3	φ1.0×4	φ1.0×5	φ1.0×7	φ1.0×9
Rated voltage(AC.V)	500V	500V	500V	500V	400V	400V
Test voltage(AC.V) 1min	1500V	1500V	1500V	1500V	1200V	1200V
Contact resistance mΩ	2.5	2.5	5	5	5	5
Wire size solder mm ² /AWG	≤2/14	≤2/14	≤0.785/18	≤0.785/18	≤0.785/18	≤0.785/18

GENERAL TOLERANCE		PROJECTION	Description:
.X	±0.05	UNITS	mm
.XX	±0.02	SHEET SIZE	A4
		KLS P/N:	KLS15-W17A1-XX
Draw:	Daniel	2018-08-27	NingBo KLS ELECTRONIC CO.,L TD.
Check:	Daniel	2018-08-27	
SCALE	1:1	SHEET	