

Rail-to-rail output current quad operational amplifier

Datasheet - production data

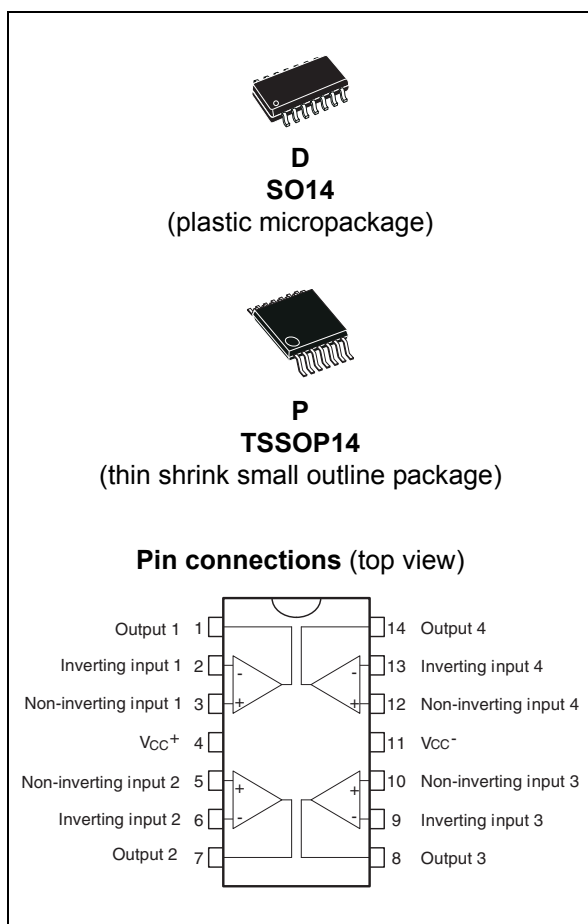

Features

- Rail-to-rail input and output
- Low noise: $9 \text{ nV}/\sqrt{\text{Hz}}$
- Low distortion
- High output current: 80 mA (able to drive 32Ω loads)
- High-speed: 4 MHz, $1.3 \text{ V}/\mu\text{s}$
- Operating range from 2.7 V to 12 V
- Low input offset voltage: 900 μV max. (TS924A)

- ESD internal protection: 3 kV
- Latch-up immunity
- Macromodel included in this specification

Related products

- See the TS921 device for the single version and the TS922 device for the dual version
- See the TSX56x series for smaller packages

Applications

- Headphone amplifiers
- Piezoelectric speaker drivers
- Sound cards
- MPEG boards, multimedia systems
- Line drivers, buffers
- Cordless telephones and portable communication equipment
- Instrumentation with low noise as key factor

Description

The TS924 and TS924A devices are rail-to-rail quad BiCMOS operational amplifiers optimized and fully specified for 3 V and 5 V operation.

High output current allows low load impedances to be driven.

The TS924 and TS924A devices exhibit a very low noise, low distortion, low offset, and high output current capability, making these devices an excellent choice for high-quality, low-voltage, and battery-operated audio systems.

The devices are stable for capacitive loads up to 500 pF.

Contents

- 1 Absolute maximum ratings and operating conditions 3**
- 2 Electrical characteristics 4**
- 3 Macromodel 10**
 - 3.1 Important note concerning this macromodel 10
 - 3.2 Electrical characteristics from macromodelization 10
 - 3.3 Macromodel code 11
- 4 Package information 13**
 - 4.1 SO14 package information 14
 - 4.2 TSSOP14 package information 15
- 5 Ordering information 16**
- 6 Revision history 17**



1 Absolute maximum ratings and operating conditions

Table 1. Absolute maximum ratings

Symbol	Parameter	Value	Unit
V_{CC}	Supply voltage ⁽¹⁾	14	V
V_{id}	Differential input voltage ⁽²⁾	± 1	
V_{in}	Input voltage ⁽³⁾	$V_{CC-} - 0.3$ to $V_{CC+} + 0.3$	
T_{stg}	Storage temperature	-65 to +150	°C
T_j	Maximum junction temperature	150	
R_{thja}	Thermal resistance junction-to-ambient ⁽⁴⁾		°C/W
	SO14 TSSOP14	66 100	
ESD	HBM: human body model ⁽⁵⁾	3	kV
	MM: machine model ⁽⁶⁾	100	V
	CDM: charged device model ⁽⁷⁾ SO14 TSSOP14	1.5 1	kV
	Output short-circuit duration	See footnote ⁽⁸⁾	
	Latch-up immunity	200	mA
	Soldering temperature (10 sec.), leaded version	250	°C
	Soldering temperature (10 sec.), unleaded version	260	

- All voltage values, except the differential voltage, are with respect to network ground terminal.
- The differential voltage is the non-inverting input terminal with respect to the inverting input terminal. If $V_{id} > \pm 1$ V, the maximum input current must not exceed ± 1 mA. In this case ($V_{id} > \pm 1$ V), an input series resistor must be added to limit input current.
- Do not exceed 14 V.
- Short-circuits can cause excessive heating and destructive dissipation. R_{th} are typical values.
- Human body model: a 100 pF capacitor is charged to the specified voltage, then discharged through a 1.5 k Ω resistor between two pins of the device. This is done for all couples of connected pin combinations while the other pins are floating.
- Machine model: a 200 pF capacitor is charged to the specified voltage, then discharged directly between two pins of the device with no external series resistor (internal resistor < 5 Ω). This is done for all couples of connected pin combinations while the other pins are floating.
- Charged device model: all pins and the package are charged together to the specified voltage and then discharged directly to ground through only one pin. This is done for all pins.
- There is no short-circuit protection inside the device: short-circuits from the output to V_{CC} can cause excessive heating. The maximum output current is approximately 80 mA, independent of the magnitude of V_{CC} . Destructive dissipation can result from simultaneous short-circuits on all amplifiers.

Table 2. Operating conditions

Symbol	Parameter	Value	Unit
V_{CC}	Supply voltage	2.7 to 12	V
V_{icm}	Common mode input voltage range	$V_{CC-} - 0.2$ to $V_{CC+} + 0.2$	
T_{oper}	Operating free air temperature range	-40 to +125	°C

2 Electrical characteristics

Table 3. Electrical characteristics at $V_{CC+} = +3\text{ V}$ with $V_{CC-} = 0\text{ V}$, $V_{icm} = V_{CC+}/2$, $T_{amb} = 25\text{ °C}$, and R_L connected to $V_{CC+}/2$ (unless otherwise specified)

Symbol	Parameter	Min.	Typ.	Max.	Unit
DC performance					
V_{io}	Input offset voltage TS924 TS924A $T_{min} \leq T_{amb} \leq T_{max}$			3 0.9	mV
	TS924 TS924A			5 1.8	
DV_{io}	Input offset voltage drift		2		$\mu\text{V}/\text{°C}$
I_{io}	Input offset current - $T_{min} \leq T_{amb} \leq T_{max}$		1	30	nA
I_{ib}	Input bias current - $T_{min} \leq T_{amb} \leq T_{max}$		15	100	
CMR	V_{icm} from 0 to 3 V $T_{min} \leq T_{amb} \leq T_{max}$	60 56	80		dB
	SVR	Supply voltage rejection ratio - $V_{CC+} = 2.7$ to 3.3 V $T_{min} \leq T_{amb} \leq T_{max}$	60 60	85	
A_{vd}	Large signal voltage gain ($V_{out} = 2 V_{pk-pk}$) $R_L = 10\text{ k}\Omega$, $T_{min} \leq T_{amb} \leq T_{max}$ $R_L = 600\ \Omega$, $T_{min} \leq T_{amb} \leq T_{max}$ $R_L = 32\ \Omega$	70	200		V/mV
		15	35		
			16		
V_{OH}	High level output voltage $R_L = 10\text{ k}\Omega$, $T_{min} \leq T_{amb} \leq T_{max}$ $R_L = 600\ \Omega$, $T_{min} \leq T_{amb} \leq T_{max}$ $R_L = 32\ \Omega$	2.90 2.87			V
			2.63		
V_{OL}	Low level output voltage $R_L = 10\text{ k}\Omega$, $T_{min} \leq T_{amb} \leq T_{max}$ $R_L = 600\ \Omega$, $T_{min} \leq T_{amb} \leq T_{max}$ $R_L = 32\ \Omega$			50 100	mV
			180		
I_o	Output short-circuit current	50	80		mA
I_{CC}	Supply current /operator - no load, $V_{out} = V_{CC+}/2$ $T_{min} \leq T_{amb} \leq T_{max}$		1	1.5 1.6	
AC performance					
GBP	Gain bandwidth product - $R_L = 600\ \Omega$		4		MHz
ϕ_m	Phase margin at unit gain - $R_L = 600\ \Omega$, $C_L = 100\text{ pF}$		68		Degrees
G_m	Gain margin - $R_L = 600\ \Omega$, $C_L = 100\text{ pF}$		12		dB
SR	Slew rate	0.7	1.3		V/ μs
e_n	Equivalent input noise voltage - $f = 1\text{ kHz}$		9		$\frac{\text{nV}}{\sqrt{\text{Hz}}}$

Table 3. Electrical characteristics at $V_{CC+} = +3\text{ V}$ with $V_{CC-} = 0\text{ V}$, $V_{icm} = V_{CC+}/2$, $T_{amb} = 25\text{ °C}$, and R_L connected to $V_{CC+}/2$ (unless otherwise specified) (continued)

Symbol	Parameter	Min.	Typ.	Max.	Unit
THD	Total harmonic distortion $V_{out} = 2 V_{pk-pk}$, $F = 1\text{ kHz}$, $A_v = 1$, $R_L = 600\ \Omega$		0.005		%
C_s	Channel separation		120		dB

Table 4. $V_{CC+} = +5\text{ V}$, $V_{CC-} = 0\text{ V}$, $V_{icm} = V_{CC}/2$, $T_{amb} = 25\text{ }^\circ\text{C}$, R_L connected to $V_{CC}/2$ (unless otherwise specified)

Symbol	Parameter	Min.	Typ.	Max.	Unit
DC performance					
V_{io}	Input offset voltage TS924 TS924A $T_{min} \leq T_{amb} \leq T_{max}$			3 0.9	mV
	TS924 TS924A			5 1.8	
DV_{io}	Input offset voltage drift		2		$\mu\text{V}/^\circ\text{C}$
I_{io}	Input offset current - $T_{min} \leq T_{amb} \leq T_{max}$		1	30	nA
I_{ib}	Input bias current - $T_{min} \leq T_{amb} \leq T_{max}$		15	100	
CMR	V_{icm} from 0 to 5 V $T_{min} \leq T_{amb} \leq T_{max}$	60 56	80		dB
	SVR	Supply voltage rejection ratio - $V_{CC+} = 3\text{ V to } 5\text{ V}$ $T_{min} \leq T_{amb} \leq T_{max}$	60 60	85	
A_{vd}	Large signal voltage gain ($V_{out} = 2V_{pk-pk}$) $R_L = 10\text{ k}\Omega$, $T_{min} \leq T_{amb} \leq T_{max}$ $R_L = 600\ \Omega$, $T_{min} \leq T_{amb} \leq T_{max}$ $R_L = 32\ \Omega$	70	200		V/mV
		20	40		
			17		
V_{OH}	High level output voltage $R_L = 10\text{ k}\Omega$, $T_{min} \leq T_{amb} \leq T_{max}$ $R_L = 600\ \Omega$, $T_{min} \leq T_{amb} \leq T_{max}$ $R_L = 32\ \Omega$	4.90 4.85			V
			4.4		
V_{OL}	Low level output voltage $R_L = 10\text{ k}\Omega$, $T_{min} \leq T_{amb} \leq T_{max}$ $R_L = 600\ \Omega$, $T_{min} \leq T_{amb} \leq T_{max}$ $R_L = 32\ \Omega$			50 120	mV
			300		
I_o	Output short-circuit current	50	80		mA
I_{CC}	Supply current / operator - no load, $V_{out} = V_{CC+}/2$ $T_{min} \leq T_{amb} \leq T_{max}$		1	1.5 1.6	
AC performance					
GBP	Gain bandwidth product - $R_L = 600\ \Omega$		4		MHz
ϕ_m	Phase margin at unit gain - $R_L = 600\ \Omega$, $C_L = 100\text{ pF}$		68		Degrees
G_m	Gain margin - $R_L = 600\ \Omega$, $C_L = 100\text{ pF}$		12		dB
SR	Slew rate	0.7	1.3		$\text{V}/\mu\text{s}$
e_n	Equivalent input noise voltage - $f = 1\text{ kHz}$		9		$\frac{\text{nV}}{\sqrt{\text{Hz}}}$
THD	Total harmonic distortion $V_{out} = 2\text{ V}_{pk-pk}$, $F = 1\text{ kHz}$, $A_v = 1$, $R_L = 600\ \Omega$		0.005		%
C_s	Channel separation		120		dB

Figure 1. Output short-circuit current vs. output voltage ($V_{CC} = 0/12\text{ V}$)

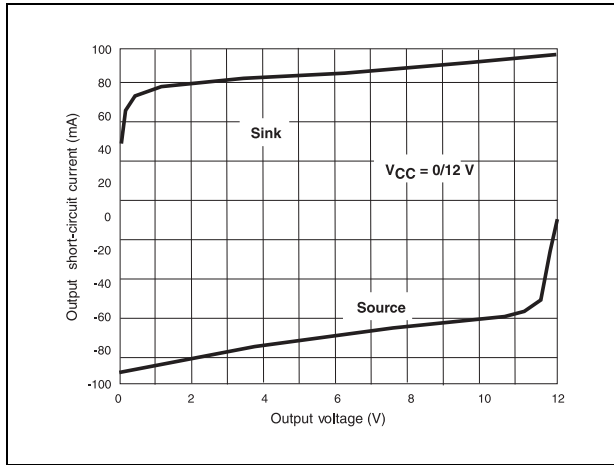

Figure 2. Output short-circuit current vs. output voltage ($V_{CC} = 0/3\text{ V}$)

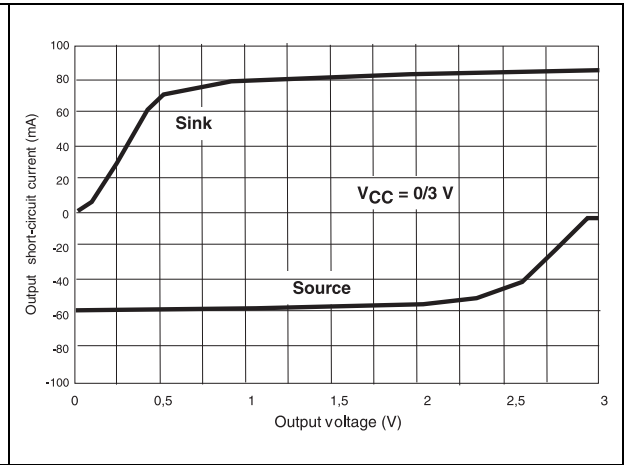

Figure 3. Voltage gain and phase vs. frequency ($C_L = 500\text{ pF}$, $V_{CC} = \pm 1.5\text{ V}$)

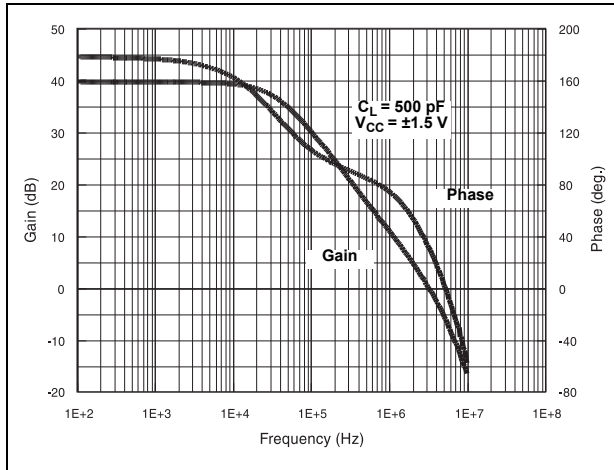

Figure 4. Output short-circuit current vs. output voltage ($V_{CC} = 0/5\text{ V}$)

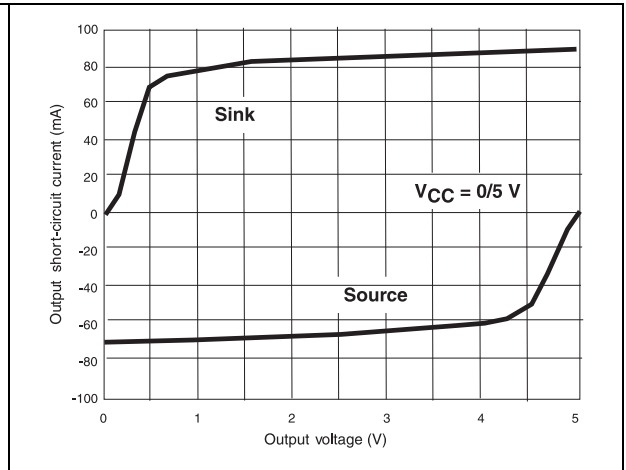

Figure 5. Voltage gain and phase vs. frequency ($R_L = 10\text{ k}\Omega$, $C_L = 100\text{ pF}$, $V_{CC} = \pm 1.5\text{ V}$)

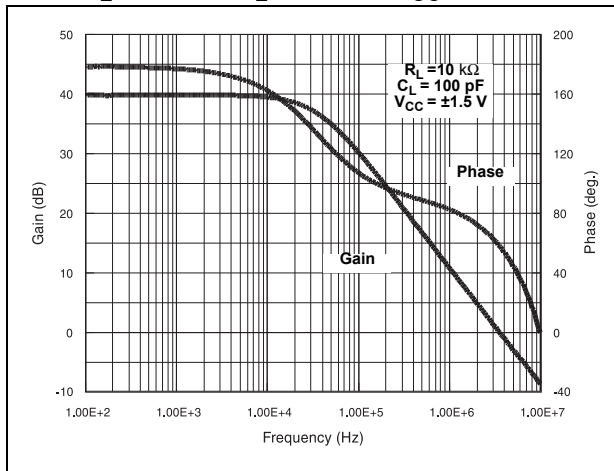

Figure 6. THD + noise vs. frequency ($R_L = 2\text{ k}\Omega$, $V_O = 10\text{ Vpp}$, $V_{CC} = \pm 6\text{ V}$, $A_v = -1$)

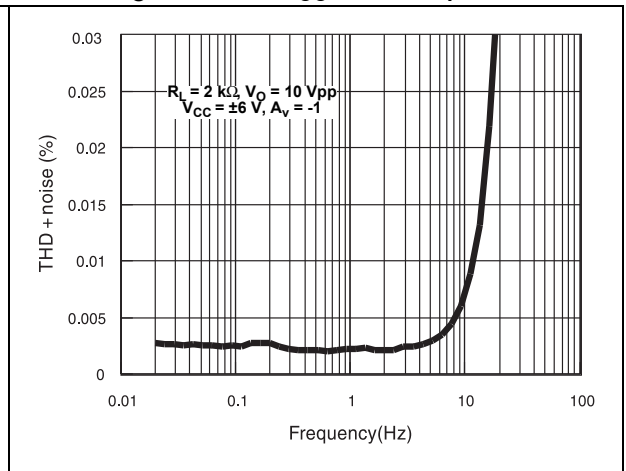

Figure 7. THD + noise vs. frequency ($R_L = 2\text{ k}\Omega$, $V_O = 10\text{ Vpp}$, $V_{CC} = \pm 6\text{ V}$, $A_V = 1$)

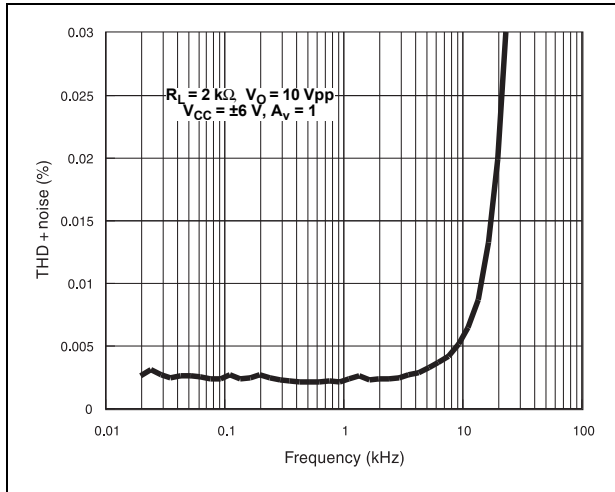

Figure 8. THD + noise vs. frequency ($R_L = 32\ \Omega$, $V_O = 2\text{ Vpp}$, $V_{CC} = \pm 1.5\text{ V}$, $A_V = 10$)

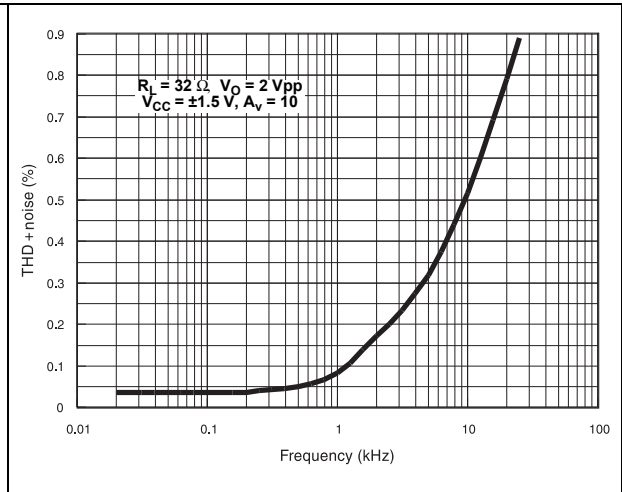

Figure 9. THD + noise vs. V_{out} ($R_L = 32\ \Omega$, $f = 1\text{ kHz}$, $V_{CC} = \pm 1.5\text{ V}$, $A_V = -1$)

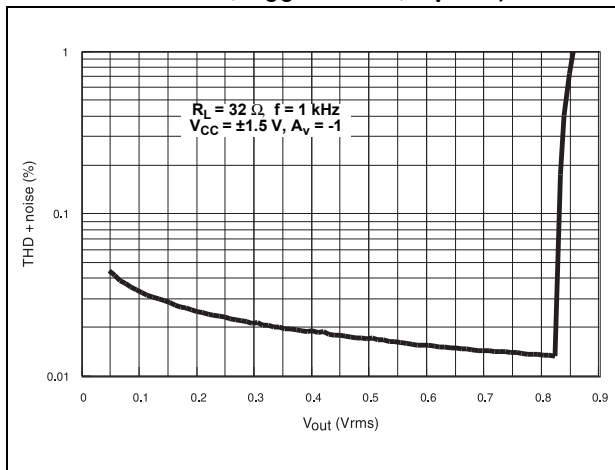

Figure 10. THD + noise vs. frequency ($R_L = 32\ \Omega$, $V_O = 4\text{ Vpp}$, $V_{CC} = \pm 2.5\text{ V}$, $A_V = 1$)

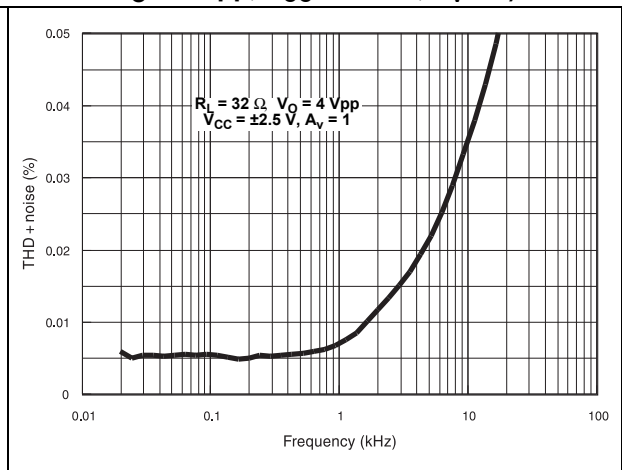

Figure 11. THD + noise vs. V_{out} ($R_L = 600\ \Omega$, $f = 1\text{ kHz}$, $V_{CC} = \pm 1.5\text{ V}$, $A_V = -1$)

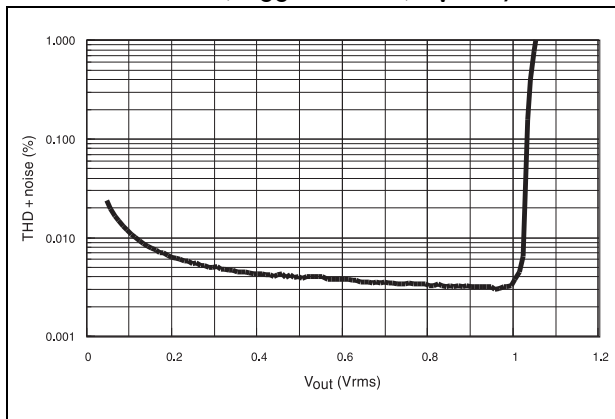

Figure 12. THD + noise vs. V_{out} ($R_L = 2\text{ k}\Omega$, $f = 1\text{ kHz}$, $V_{CC} = \pm 1.5\text{ V}$, $A_V = -1$)

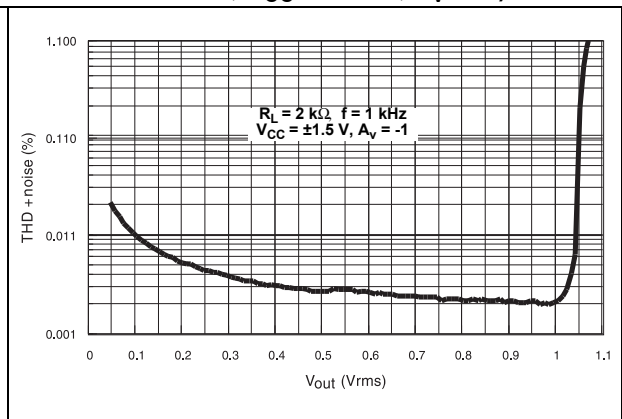
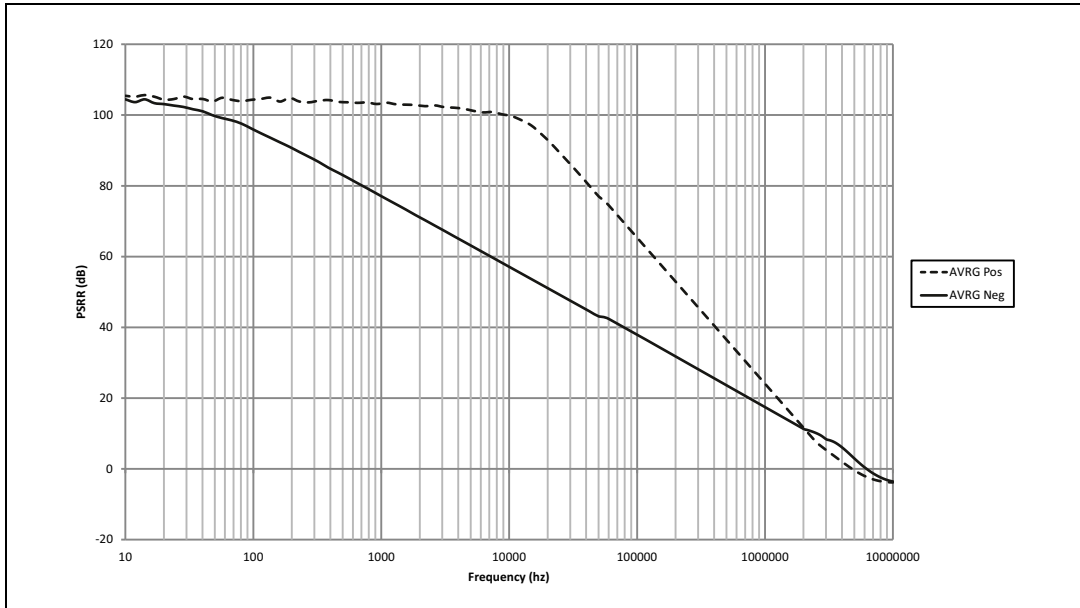

Figure 13. PSRR for TS924/TS924A at $V_{CC} = 5\text{ V}$, $V_{icm} = 2.5\text{ V}$, $T = 25\text{ }^\circ\text{C}$, $R_I = 100\text{ k}\Omega$, and $C_I = 100\text{ pF}$



3 Macromodel

3.1 Important note concerning this macromodel

Note the following remarks before using this macromodel:

- All models are a trade-off between accuracy and complexity (that is, simulation time).
- Macromodels are not a substitute to breadboarding; rather, they confirm the validity of a design approach and help to select surrounding component values.
- A macromodel emulates the **nominal** performance of a **typical** device within **specified operating conditions** (for example, temperature, supply voltage). Thus, the macromodel is often not as exhaustive as the datasheet, its purpose is to illustrate the main parameters of the product.

Data derived from macromodels used outside of the specified conditions (such as V_{CC} and temperature) or worse, outside of the device operating conditions (such as V_{CC} and V_{icm}), are not reliable in any way.

[Section 3.2](#) presents the electrical characteristics resulting from the use of these macromodels.

3.2 Electrical characteristics from macromodelization

Table 5. Macromodel simulation at $V_{CC+} = 3\text{ V}$, $V_{CC-} = 0\text{ V}$, R_L , C_L connected to $V_{CC}/2$, and $T_{amb} = 25\text{ °C}$ (unless otherwise specified)

Symbol	Conditions	Value	Unit
V_{io}		0	mV
A_{vd}	$R_L = 10\text{ k}\Omega$	200	V/mV
I_{CC}	No load, per operator	1.2	mA
V_{icm}		-0.2 to 3.2	V
V_{OH}	$R_L = 10\text{ k}\Omega$	2.95	
V_{OL}	$R_L = 10\text{ k}\Omega$	25	mV
I_{sink}	$V_O = 3\text{ V}$	80	mA
I_{source}	$V_O = 0\text{ V}$	80	
GBP	$R_L = 600\text{ k}\Omega$	4	MHz
SR	$R_L = 10\text{ k}\Omega$, $C_L = 100\text{ pF}$	1	V/ μ s
ϕ_m	$R_L = 600\text{ k}\Omega$	68	Degrees

3.3 Macromodel code

```

** Standard Linear Ics Macromodels, 1996.
** CONNECTIONS:
* 1 INVERTING INPUT
* 2 NON-INVERTING INPUT
* 3 OUTPUT
* 4 POSITIVE POWER SUPPLY
* 5 NEGATIVE POWER SUPPLY

.SUBCKT TS92X 1 2 3 4 5
*
.MODEL MDTH D IS=1E-8 KF=2.664234E-16 CJO=10F
*
* INPUT STAGE
CIP 2 5 1.000000E-12
CIN 1 5 1.000000E-12
EIP 10 5 2 5 1
EIN 16 5 1 5 1
RIP 10 11 8.125000E+00
RIN 15 16 8.125000E+00
RIS 11 15 2.238465E+02
DIP 11 12 MDTH 400E-12
DIN 15 14 MDTH 400E-12
VOFP 12 13 DC 153.5u
VOFN 13 14 DC 0
IPOL 13 5 3.200000E-05
CPS 11 15 1e-9
DINN 17 13 MDTH 400E-12
VIN 17 5 -0.100000e+00
DINR 15 18 MDTH 400E-12
VIP 4 18 0.400000E+00
FCP 4 5 VOFP 1.865000E+02
FCN 5 4 VOFN 1.865000E+02
FIBP 2 5 VOFP 6.250000E-03
FIBN 5 1 VOFN 6.250000E-03
* GM1 STAGE *****
FGM1P 119 5 VOFP 1.1
FGM1N 119 5 VOFN 1.1
RAP 119 4 2.6E+06
RAN 119 5 2.6E+06
* GM2 STAGE *****
G2P 19 5 119 5 1.92E-02
G2N 19 5 119 4 1.92E-02
R2P 19 4 1E+07

```

```
R2N 19 5 1E+07
*****
VINT1 500 0 5
GCONVP 500 501 119 4 19.38
VP 501 0 0
GCONVN 500 502 119 5 19.38
VN 502 0 0
***** orientation isink isource *****
VINT2 503 0 5
FCOPY 503 504 VOUT 1
DCOPYP 504 505 MDTH 400E-9
VCOPYP 505 0 0
DCOPYN 506 504 MDTH 400E-9
VCOPYN 0 506 0
*****
F2PP 19 5 poly(2) VCOPYP VP 0 0 0 0 0.5
F2PN 19 5 poly(2) VCOPYP VN 0 0 0 0 0.5
F2NP 19 5 poly(2) VCOPYN VP 0 0 0 0 1.75
F2NN 19 5 poly(2) VCOPYN VN 0 0 0 0 1.75
* COMPENSATION *****
CC 19 119 25p
* OUTPUT *****
DOPM 19 22 MDTH 400E-12
DONM 21 19 MDTH 400E-12
HOPM 22 28 VOUT 6.250000E+02
VIPM 28 4 5.000000E+01
HONM 21 27 VOUT 6.250000E+02
VINM 5 27 5.000000E+01
VOUT 3 23 0
ROUT 23 19 6
COUT 3 5 1.300000E-10
DOP 19 25 MDTH 400E-12
VOP 4 25 1.052
DON 24 19 MDTH 400E-12
VON 24 5 1.052
.ENDS ;TS92X
```

4 Package information

In order to meet environmental requirements, ST offers these devices in different grades of ECOPACK[®] packages, depending on their level of environmental compliance. ECOPACK specifications, grade definitions and product status are available at: www.st.com. ECOPACK is an ST trademark.

4.1 SO14 package information

Figure 14. SO14 package outline

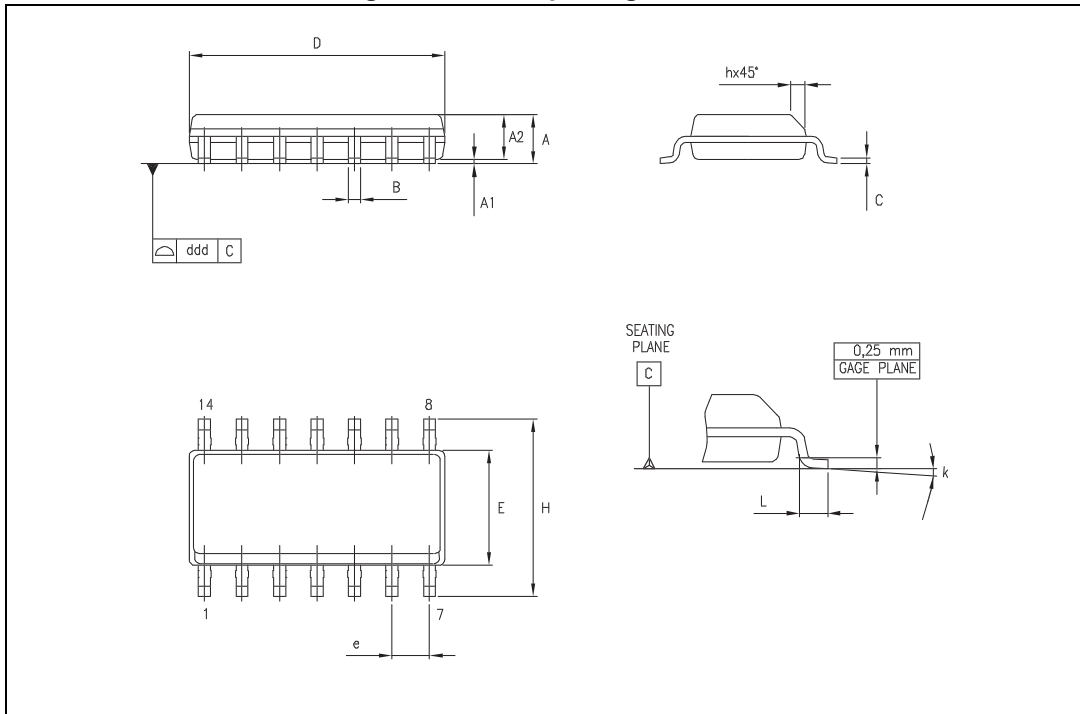

Table 6. SO14 package mechanical data

Symbol	Dimensions					
	Millimeters			Inches		
	Min.	Typ.	Max.	Min.	Typ.	Max.
A	1.35		1.75	0.05		0.068
A1	0.10		0.25	0.004		0.009
A2	1.10		1.65	0.04		0.06
B	0.33		0.51	0.01		0.02
C	0.19		0.25	0.007		0.009
D	8.55		8.75	0.33		0.34
E	3.80		4.0	0.15		0.15
e		1.27			0.05	
H	5.80		6.20	0.22		0.24
h	0.25		0.50	0.009		0.02
L	0.40		1.27	0.015		0.05
k	8° (max.)					
ddd			0.10			0.004

4.2 TSSOP14 package information

Figure 15. TSSOP14 package outline

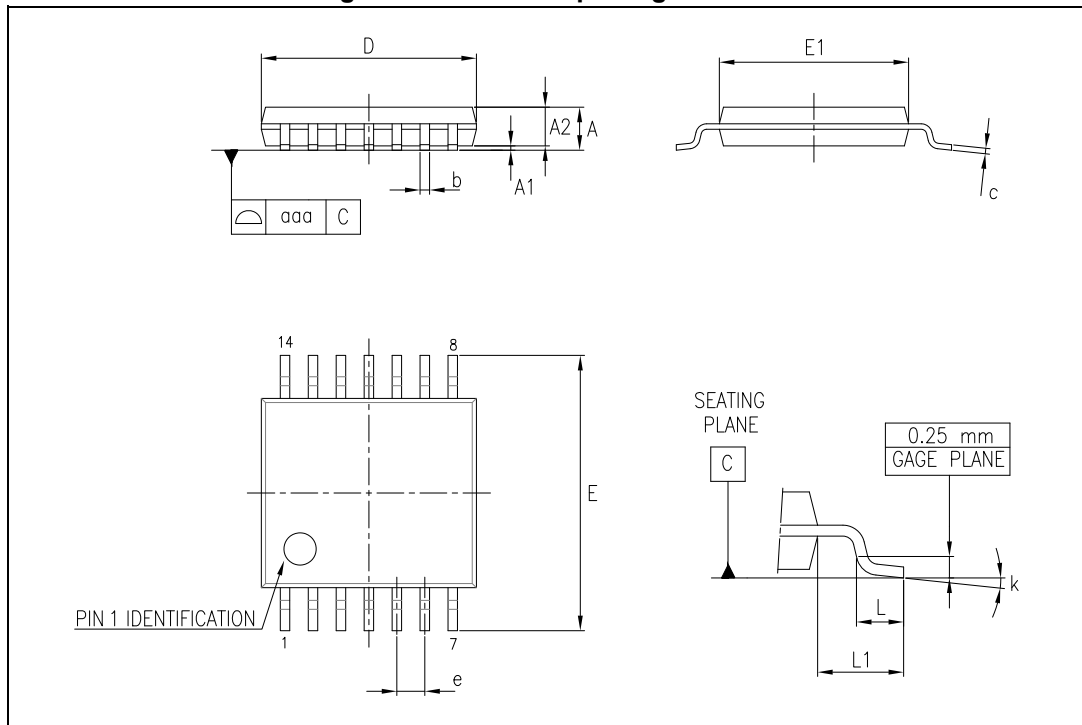

Table 7. TSSOP14 package mechanical data

Symbol	Dimensions					
	Millimeters			Inches		
	Min.	Typ.	Max.	Min.	Typ.	Max.
A			1.20			0.047
A1	0.05		0.15	0.002	0.004	0.006
A2	0.80	1.00	1.05	0.031	0.039	0.041
b	0.19		0.30	0.007		0.012
c	0.09		0.20	0.004		0.0089
D	4.90	5.00	5.10	0.193	0.197	0.201
E	6.20	6.40	6.60	0.244	0.252	0.260
E1	4.30	4.40	4.50	0.169	0.173	0.176
e		0.65			0.0256	
L	0.45	0.60	0.75	0.018	0.024	0.030
L1		1.00			0.039	
k	0°		8°	0°		8°
aaa			0.10			0.004

5 Ordering information

Table 8. Order codes

Order code	Temperature range	Package	Packaging	Marking
TS924ID TS924IDT	-40 °C, 125 °C	SO14	Tube or tape and reel	924I
TS924AID TS924AIDT				924AI
TS924IYDT ⁽¹⁾		SO14 (automotive grade)	Tape and reel	924IY
TS924AIYDT ⁽¹⁾				924AIY
TS924IPT		TSSOP14		924I
TS924AIPT				924AI
TS924IYPT ⁽¹⁾		TSSOP14 (automotive grade)		924IY
TS924AIYPT ⁽¹⁾				924AIY

1. Qualified and characterized according to AEC Q100 and Q003 or equivalent, advanced screening according to AEC Q001 and Q 002 or equivalent.

6 Revision history

Table 9. Document revision history

Date	Revision	Changes
28-May-2001	1	First release.
12-May-2005	2	Modifications on AMR Table on page 3 (explanation of V_{id} and V_{in} limits, ESD MM and CDM values added, R_{thja} added).
31-Jul-2005	3	PPAP references inserted in the datasheet, see order codes table.
30-Nov-2005	4	Package mechanical data modified. TS924IYPT/TS924AYIPT PPAP reference inserted in order code table. Macromodel modified.
11-Mar-2008	5	Added footnotes for automotive grade order codes in Table 8: Order codes . Updated document format.
19-Dec-2008	6	ESD tolerance improved for machine model in Table 1: Absolute maximum ratings . Removed TS914AIN order code and corrected footnotes in Table 8: Order codes .
08-Oct-2009	7	Added part number TS924A on cover page. Added limits on full temperature range in Table 3 and Table 4 . Removed order codes TS924IYD and TS924AIYD from Table 8 .
15-Apr-2011	8	Modified CMR parameter values in Table 3 and Table 4 .
19-May-2011	9	Added A version in title and header.
04-Dec-2012	10	Added DIP14 package to Figure on page 1. Added Related products to Features . Added DIP14 with value for R_{thja} in Table 1 . Added conditions to titles of Figure 1 to Figure 12 . Replaced V_{CC} by V_{CC+} and V_{DD} by V_{CC-} in title of Table 5 . Qualified status of TS924IYPT and TS924AIYPT order codes in Table 8 . Minor corrections throughout document.
05-Jun-2014	11	Removed DIP14 package and order code pertaining to it Added Figure 13

Please Read Carefully:

Information in this document is provided solely in connection with ST products. STMicroelectronics NV and its subsidiaries ("ST") reserve the right to make changes, corrections, modifications or improvements, to this document, and the products and services described herein at any time, without notice.

All ST products are sold pursuant to ST's terms and conditions of sale.

Purchasers are solely responsible for the choice, selection and use of the ST products and services described herein, and ST assumes no liability whatsoever relating to the choice, selection or use of the ST products and services described herein.

No license, express or implied, by estoppel or otherwise, to any intellectual property rights is granted under this document. If any part of this document refers to any third party products or services it shall not be deemed a license grant by ST for the use of such third party products or services, or any intellectual property contained therein or considered as a warranty covering the use in any manner whatsoever of such third party products or services or any intellectual property contained therein.

UNLESS OTHERWISE SET FORTH IN ST'S TERMS AND CONDITIONS OF SALE ST DISCLAIMS ANY EXPRESS OR IMPLIED WARRANTY WITH RESPECT TO THE USE AND/OR SALE OF ST PRODUCTS INCLUDING WITHOUT LIMITATION IMPLIED WARRANTIES OF MERCHANTABILITY, FITNESS FOR A PARTICULAR PURPOSE (AND THEIR EQUIVALENTS UNDER THE LAWS OF ANY JURISDICTION), OR INFRINGEMENT OF ANY PATENT, COPYRIGHT OR OTHER INTELLECTUAL PROPERTY RIGHT.

ST PRODUCTS ARE NOT DESIGNED OR AUTHORIZED FOR USE IN: (A) SAFETY CRITICAL APPLICATIONS SUCH AS LIFE SUPPORTING, ACTIVE IMPLANTED DEVICES OR SYSTEMS WITH PRODUCT FUNCTIONAL SAFETY REQUIREMENTS; (B) AERONAUTIC APPLICATIONS; (C) AUTOMOTIVE APPLICATIONS OR ENVIRONMENTS, AND/OR (D) AEROSPACE APPLICATIONS OR ENVIRONMENTS. WHERE ST PRODUCTS ARE NOT DESIGNED FOR SUCH USE, THE PURCHASER SHALL USE PRODUCTS AT PURCHASER'S SOLE RISK, EVEN IF ST HAS BEEN INFORMED IN WRITING OF SUCH USAGE, UNLESS A PRODUCT IS EXPRESSLY DESIGNATED BY ST AS BEING INTENDED FOR "AUTOMOTIVE, AUTOMOTIVE SAFETY OR MEDICAL" INDUSTRY DOMAINS ACCORDING TO ST PRODUCT DESIGN SPECIFICATIONS. PRODUCTS FORMALLY ESCC, QML OR JAN QUALIFIED ARE DEEMED SUITABLE FOR USE IN AEROSPACE BY THE CORRESPONDING GOVERNMENTAL AGENCY.

Resale of ST products with provisions different from the statements and/or technical features set forth in this document shall immediately void any warranty granted by ST for the ST product or service described herein and shall not create or extend in any manner whatsoever, any liability of ST.

ST and the ST logo are trademarks or registered trademarks of ST in various countries.

Information in this document supersedes and replaces all information previously supplied.

The ST logo is a registered trademark of STMicroelectronics. All other names are the property of their respective owners.

© 2014 STMicroelectronics - All rights reserved

STMicroelectronics group of companies

Australia - Belgium - Brazil - Canada - China - Czech Republic - Finland - France - Germany - Hong Kong - India - Israel - Italy - Japan - Malaysia - Malta - Morocco - Philippines - Singapore - Spain - Sweden - Switzerland - United Kingdom - United States of America

www.st.com

Mouser Electronics

Authorized Distributor

Click to View Pricing, Inventory, Delivery & Lifecycle Information:

[STMicroelectronics:](#)

[TS924ID](#) [TS924IDT](#) [TS924AIPT](#) [TS924IPT](#) [TS924AIDT](#) [TS924AIYPT](#) [TS924IYPT](#) [TS924AIYDT](#) [TS924IYDT](#)