



Analog Telephony/Modem Couplers

FEATURES

- Suitable for modem speeds up to V.34 (33.6 kbps).
- Total Harmonic Distortion rated -82 dB typ. @ 600 Hz, -10 dBm.
- Insertion Loss rated 2.75 dB typ. @ 2000 Hz.
- Complies with IEC60950 Supplementary safety norms.
- Reflects 600 Ohms on Primary with 294 Ohms Secondary Load for 600-Ohm telephone lines.
- Uses minimal external components for impedance matching for pan-European CTR-21 telephone lines.
- Very small PCB footprint (20.0mm x 16.3 mm).
- Thin (PCMCIA) Profile (4.32 mm).
- SMT Industry-standard pin configurations.

DESCRIPTION

The Sumida SMIT -2393 is a "Dry" SMT Modem Isolation Transformer suitable for up to V.34 (33.6 kbps) consumer and internet analog modem applications compliant with Worldwide safety norms.

PRODUCT COMPLIANCE

- UL / C-UL recognized file number: E171120
- BSI certificate number(s): 8122
- BABT certificate of recognition: 1905

NOMENCLATURE (FIG. 1)

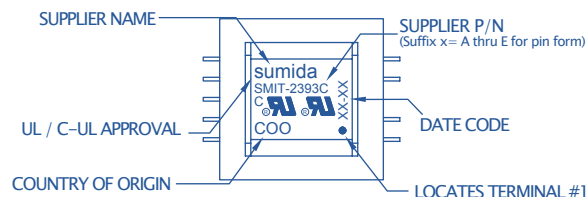

MECHANICAL DIMENSIONS (FIG. 2)

DIMENSIONS: MILLIMETERS [INCHES]

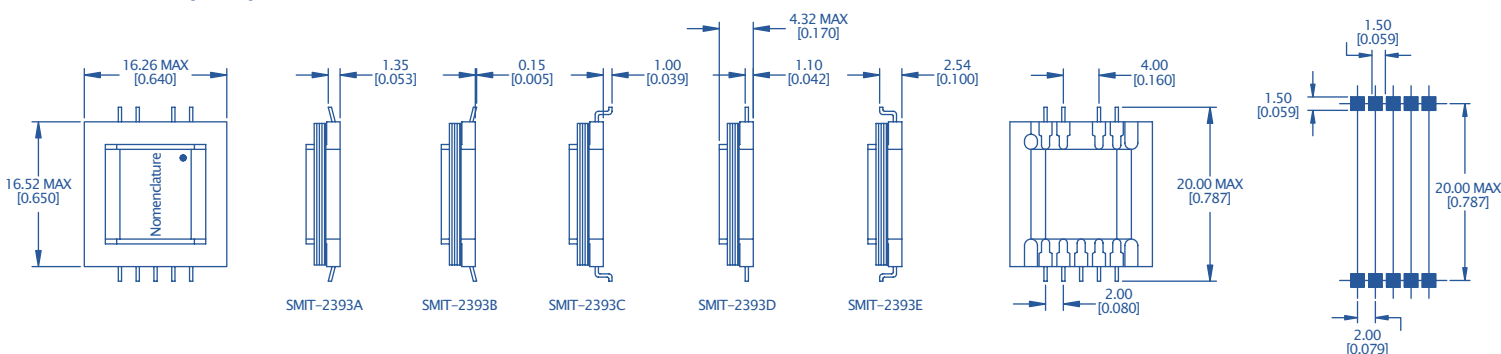

TERMINAL CONNECTION (BOTTOM VIEW)

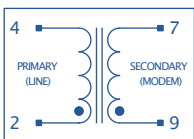

Literature number: SMIT 2393 ©Copyright 2001, Sumida Corporation All rights reserved. Printed in U.S.A. 10/01

www.sumida.com

• North America

Tel. 1 847 545 6700
Fax. 1 847 545 6720

• Hong Kong

Tel. 852 2880 6688
Fax. 852 2565 9600

• Europe

Tel. 32 89 328850
Fax. 32 11 300890

• Singapore

Tel. 65 296 3388
Fax. 65 296 3390

• Taiwan

Tel. 886 2 2523 6368
Fax. 886 2 2523 6369

• Japan

Tel. 813 3980 2212
Fax. 813 3980 2213

ELECTRICAL PERFORMANCE SPECIFICATIONS

Parameters	Conditions	Min	Typ	Max	Units
Impedance	Reflected on Primary with load on Secondary		600 294		Ohms
Total Harmonic Distortion	@ 600 Hz, -10 dBm		-82	-80	dB
Insertion Loss	Per IEEE method; @2000 Hz		2.75	6.0	dB
Return Loss	300 Hz-3500 Hz Per 600 Ohm Match (Fig. 3) Per CTR1 Pan-Euro Match (Fig.5)	20 22			dB
Dielectric Breakdown Isolation Production methods applied:	Safety Standard tested 1 min. HiPot Voltage Duration Trip Leakage Current	1500 1875 2		200	Vrms Vrms Sec μA
Frequency Response	200 Hz - 4000 Hz		±0.25		dB
Longitudinal Balance	Per FCC part 68.310 60 Hz -1000 Hz □ 1000 Hz - 4000 Hz	60 40			dB
DC Resistance @ 20°C, ±10%	Primary winding (R_{pri}) Secondary winding (R_{sec})		145 160		Ohms
DC current in Primary			0		mADC
Turns Ratio	Primary to Secondary; ±2%		1:1		Turns
Operating temperature		-40		105	°C
Storage temperature		-40		125	°C
Soldering temperature	10 Sec. Max			260	°C

Electrical Performance Specifications (TA = 25°C unless otherwise specified)

600 OHM MATCH (FIG.3)

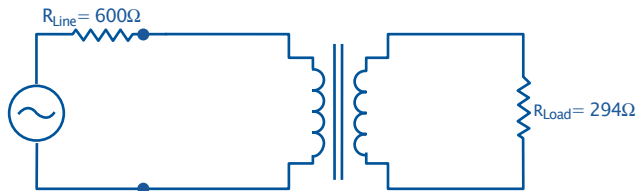

SCHEMATIC EQUIVALENT (FIG.4)

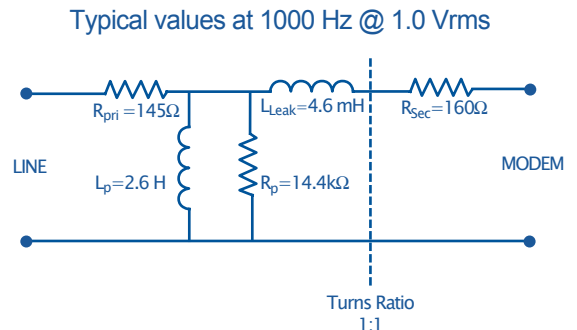

Sumida Corporation makes no assertion on warranty that the circuitry and the uses thereof disclosed herein are non-infringing on any valid US or foreign patents. Sumida assumes no liability as a result of the use of said specifications and reserves the right to make changes to specifications without notice. Sumida does not authorize or warrant any Sumida device for use in life support devices and/or systems. Contact your nearest Sumida Sales Office for the latest specifications.



PAN-EUROPEAN CTR21 MATCH (FIG.5)

(Application circuits available on request for specific national match requirements.)

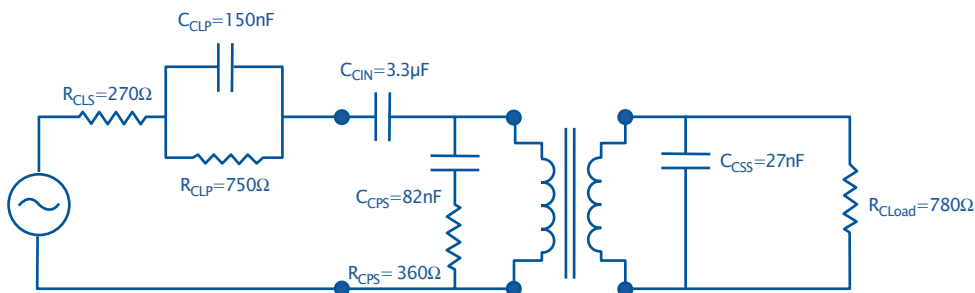

TAPE AND REEL PACKAGING (FIG.6)

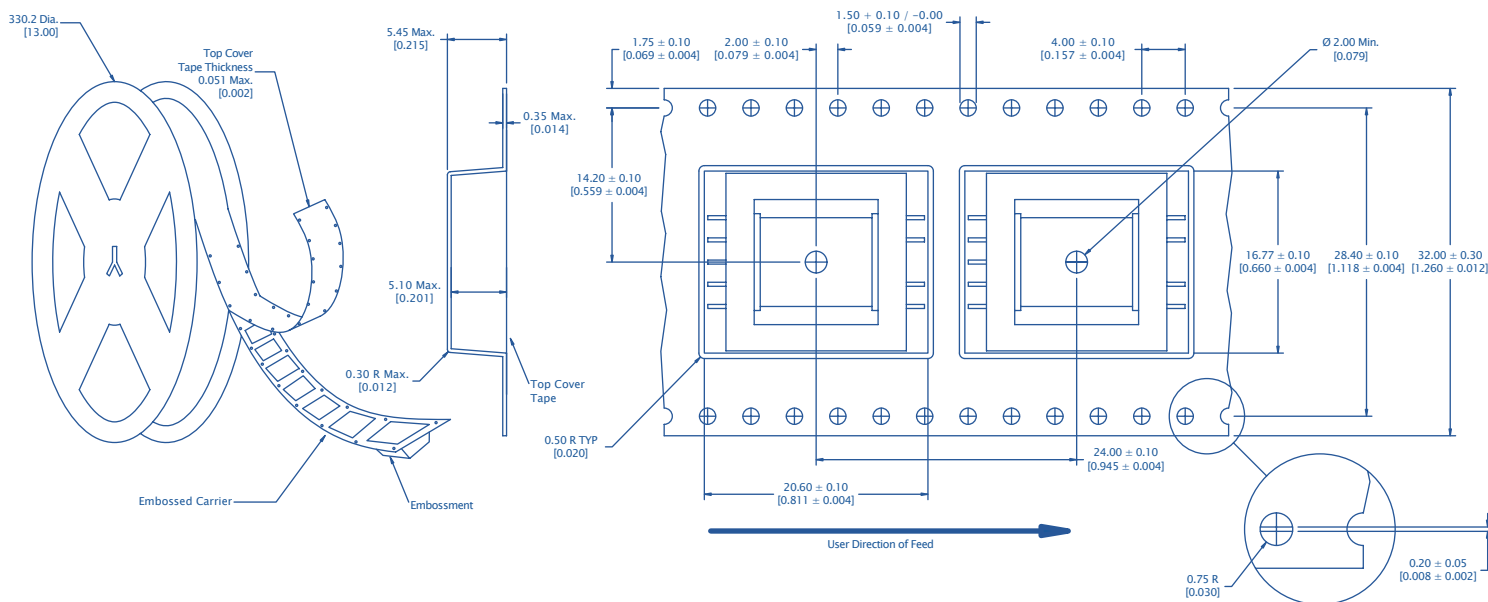

PERFORMANCE DATA

TOTAL HARMONIC DISTORTION

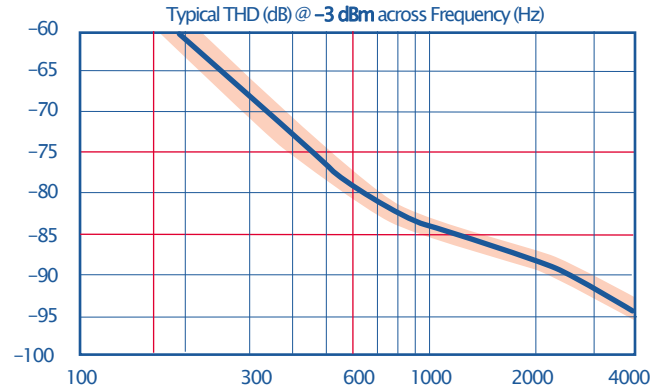
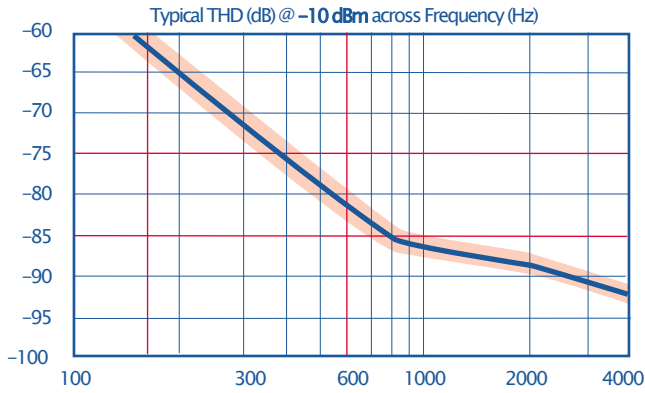

INSERTION LOSS

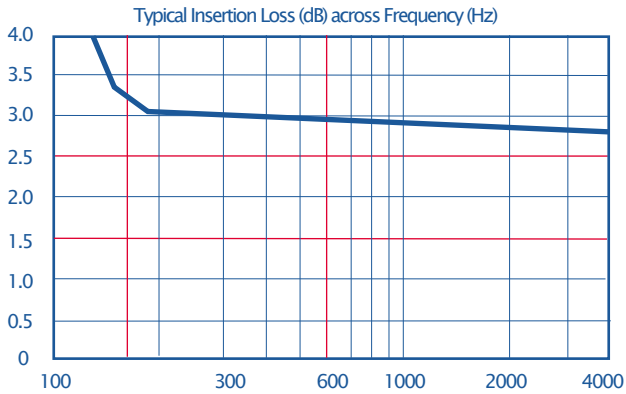

FREQUENCY RESPONSE

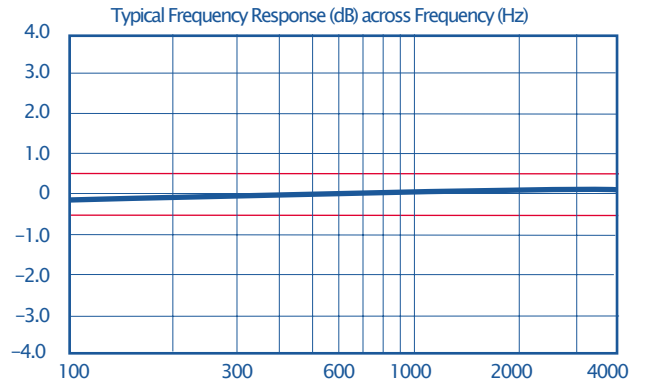

RETURN LOSS

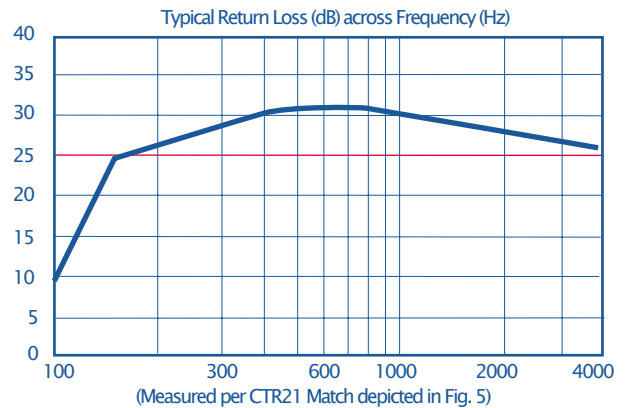
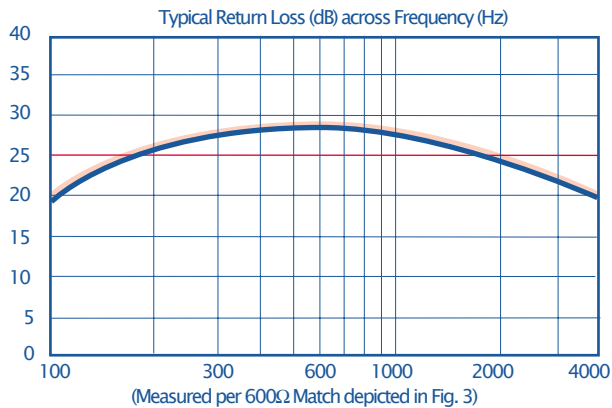

Literature number: SMT 2393 ©Copyright 2001, Sumida Corporation All rights reserved. Printed in U.S.A. 10/01

www.sumida.com

- North America
- Hong Kong
- Europe

Tel. 1 847 545 6700
 Fax. 1 847 545 6720
 Tel. 852 2880 6688
 Fax. 852 2565 9600
 Tel. 32 89 328850
 Fax. 32 11 300890

- Singapore
- Taiwan
- Japan

Tel. 65 296 3388
 Fax. 65 296 3390
 Tel. 886 2 2523 6368
 Fax. 886 2 2523 6369
 Tel. 813 3980 2212
 Fax. 813 3980 2213