

SMA Connector Series

KLS1-SMA016 SMA Connector Series

Electrical Specifications

- Impedance: 50 Ω
- Frequency Range
 - Semi-rigid cable: 0-18 GHz
 - Flexible cables: 0-12.4 GHz
- Voltage Rating : 335 volts rms.
- Dielectric Withstanding Voltage : 500 volts rms.
- VSWR :
 - 1.15 +0 .02 f (GHz) for Straight connector typical
 - 1.25 +0 .025 f (GHz) for Right angle connector typical
- Contact Resistance: Center contact: 2.0 mΩ
Body: 2.0 mΩ
- Insulation Resistance: 5,000 MΩ



Mechanical Specifications

- Mating: 1/4"-36 UNS thread coupling
- Cable retention: 6kgf typical
- Durability: 500 Cycles Min.
- Coupling nut retention: 18kgf Min.
- Temperature Range: - 55°C to +155°C

Material

- Connector body: Brass per QQ-B-626 ,gold Plating or nickel
- Center contact Male: Brass, gold Plating
- Center contact Female: Beryllium copper, gold Plating
- Insulator: PTFE
- Gasket: Silicone rubber
- Crimp Ferrule: Annealed copper

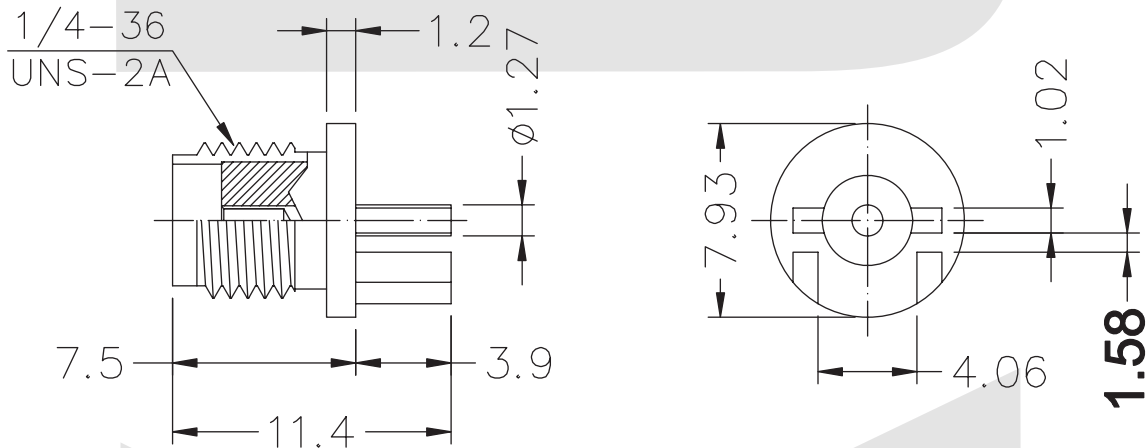

ORDER INFORMATION

Product NO.: KLS1-SMA016

Pos. NO. _____
SMA Connector Type _____