



SOT-23 Plastic-Encapsulate ESD Protection Diodes

DESCRIPTION

The SM712 transient voltage suppressor (TVS) diode is designed for asymmetrical (12V to -7V) protection in multi-point data transmission standard RS-485 applications. The SM712 may be used to protect devices from transient voltages resulting from electrostatic discharge (ESD), electrical fast transients (EFT), and lightning.

The SM712 features 400 Watts ($t_p=8/20\mu s$) of power handling capability to accommodate the higher transient voltage levels which may be expected in extended common mode applications. This provides higher equipment reliability and eliminates the “guess work” required when using zener diodes that are not rated to handle such transient conditions.

The integrated design aids in reducing voltage over-shoot associated with trace inductance. The low clamping voltage of the SM712 minimizes the stress on the protected transceiver. The SOT-23 package allows flexibility in the design of “crowded” circuit boards.

Features

- ◆ 400 Watts Peak Pulse Power per (8/20 μs)
- ◆ Transient protection for asymmetrical data lines to IEC61000-4-2 (ESD) $\pm 15kV$ (air), $\pm 8kV$ (contact) IEC61000-4-4 (EFT) 40A (5/50ns) IEC61000-4-5 (Lightning) 12A (8/20 μs)
- ◆ Protects two +12V to -7V lines
- ◆ Low capacitance
- ◆ Low leakage current
- ◆ Low clamping voltage
- ◆ Solid-state silicon avalanche technology
- ◆ Meets MSL 1 Requirements

Schematic & Pin Configuration

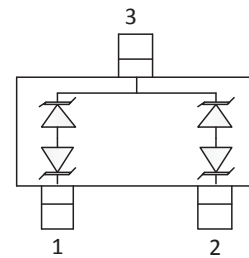

SOT23 (Top View)

Circuit Diagram

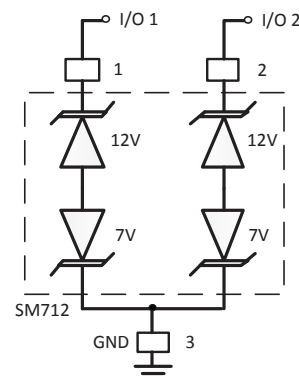

Applications

- ◆ Protection of RS-485 transceivers with extended common-mode range
- ◆ Security systems
- ◆ Automatic Teller Machines
- ◆ HFC systems
- ◆ Networks

Mechanical Characteristics

- ◆ Package: SOT-23
- ◆ Flammability Rating: UL 94V-0
- ◆ Terminal: Matte tin plated.
- ◆ High temperature soldering guaranteed: 260 $^{\circ}C$ /10s
- ◆ Marking: 712 or C72
- ◆ Packaging: Tape and Reel

**Absolute Maximum Ratings (T_A=25°C unless otherwise specified)**

Parameter	Symbol	Value	Unit
Peak Pulse Power(8/20us)	P _{PP}	400	W
Peak Pulse Current(8/20us)	I _{PP}	17	A
ESD per IEC 61000-4-2 (Air) ESD per IEC 61000-4-2 (Contact)	V _{ESD}	± 15 ± 8	KV
Operating Temperature	T _{OPT}	-55 to +150	°C
Storage Temperature	T _{STG}	-55 to +150	°C
Lead Solder Temperature – Maximum (10 Second Duration)	T _L	260(10 sec.)	°C

Electrical Characteristics (T_A=25°C unless otherwise specified)

Symbol	Parame	Test Condition	Pin 1 to 3 and Pin 2 to 3 (12V) TVS			Pin 3 to 1 and Pin 3 to 2 (7V TVS)			Units
			Min	Typ	Max	Min	Typ	Max	
V _{RWM}	Reverse Working Voltage	Pin 3 to 1 or Pin 2 to 1			12			7	V
V _{BR}	Reverse Breakdown Voltage	I _T = 1mA	13.3			7.5			V
I _R	Reverse Leakage Current	V _R = V _{RWM}			1			20	μA
V _{C1}	Clamping Voltage 1	I _{PP} = 5A, t _p = 8/20μs			20			10	V
V _{C2}	Clamping Voltage 2	I _{PP} = 17A, t _p = 8/20μs			26			12	V
C _{J1}	Junction Capacitance 1	V _R = 0V, f = 1MHz			75			75	pF
C _{J2}	Junction Capacitance 2	V _R = V _{RWM} , f = 1MHz		45			45		pF

The above data are for reference only.



ELECTRICAL CHARACTERISTICS CURVE

Non-Repetitive Peak Pulse Power vs. Pulse Time

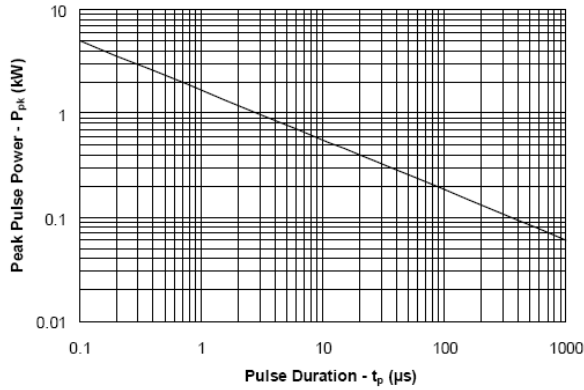

Power Derating Curve

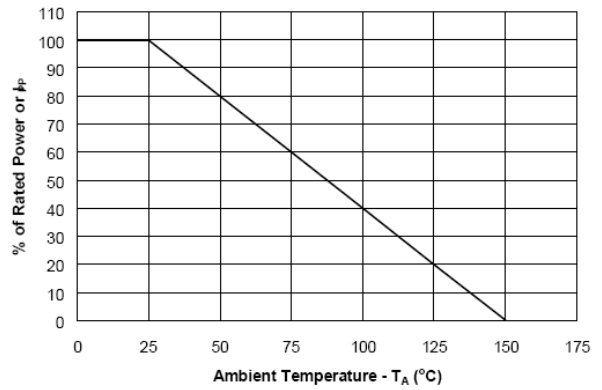

Pulse Waveform

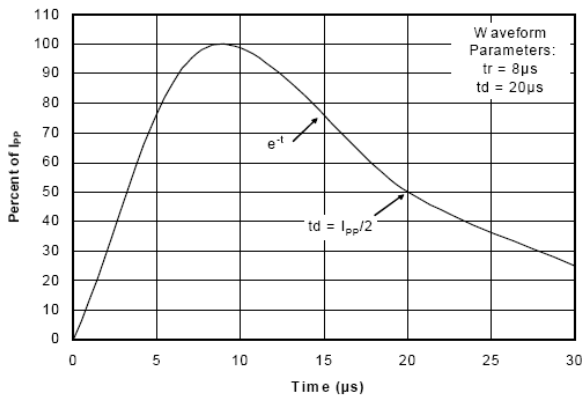

Clamping Voltage vs. Peak Pulse Current

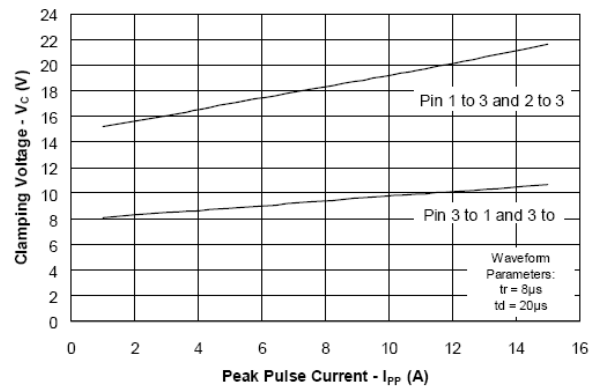

Capacitance vs. Reverse Voltage

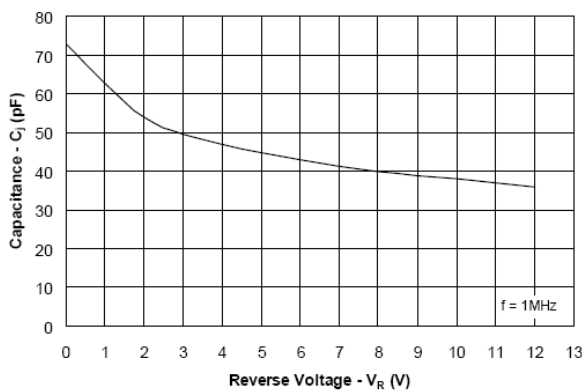

The curve above is for reference only.

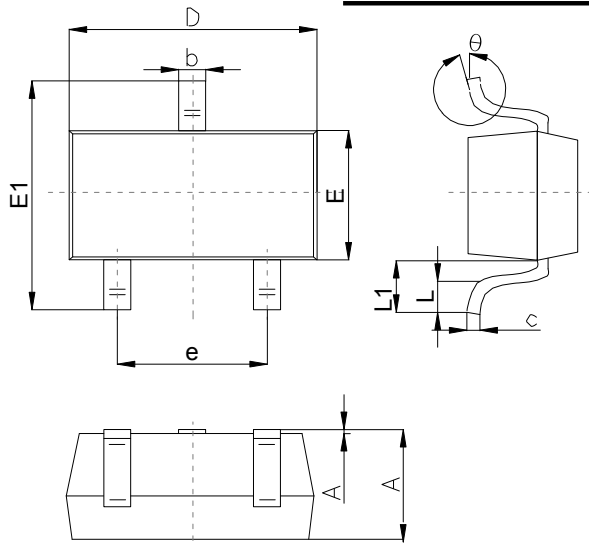
Outlitne Drawing
SOT-23 Package Outline Dimensions

Symbol	Dimensions In Millimeters		
	Min	Typ	Max
A	1.00		1.40
A1			0.10
b	0.35		0.50
c	0.10		0.20
D	2.70	2.90	3.10
E	1.40		1.60
E1	2.4		2.80
e		1.90	
L	0.10		0.30
L1	0.4		
θ	0°		10°

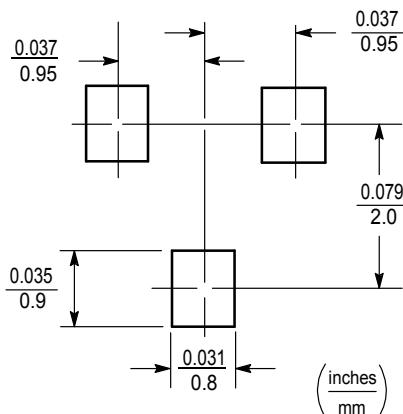
Suggested Pad Layout

Note:

1. Controlling dimension:in/millimeters.
2. General tolerance: $\pm 0.05\text{mm}$.
3. The pad layout is for reference purposes only.

Important Notice and Disclaimer

Microdiode Electronics (Jiangsu) reserves the right to make changes to this document and its products and specifications at any time without notice. Customers should obtain and confirm the latest product information and specifications before final design,purchase or use.

Microdiode Electronics (Jiangsu) makes no warranty, representation or guarantee regarding the suitability of its products for any particular purpose, not does Microdiode Electronics (Jiangsu) assume any liability for application assistance or customer product design. Microdiode Electronics (Jiangsu) does not warrant or accept any liability with products which are purchased or used for any unintended or unauthorized application.

No license is granted by implication or otherwise under any intellectual property rights of Microdiode Electronics (Jiangsu).

Microdiode Electronics (Jiangsu) products are not authorized for use as critical components in life support devices or systems without express written approval of Microdiode Electronics (Jiangsu).

SOT-23 Tape and Reel

SOT-23 Embossed Carrier Tape

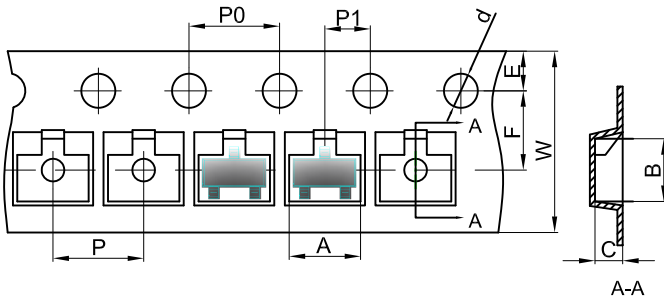

Packaging Description:

SOT-23 parts are shipped in tape. The carrier tape is made from a dissipative (carbon filled) polycarbonate resin. The cover tape is a multilayer film (Heat Activated Adhesive in nature) primarily composed of polyester film, adhesive layer, sealant, and anti-static sprayed agent. These reeled parts in standard option are shipped with 3,000 units per 7" or 17.8cm diameter reel. The reels are clear in color and is made of polystyrene plastic (anti-static coated).

Dimensions are in millimeter										
Pkg type	A	B	C	d	E	F	P0	P	P1	W
SOT-23	3.15	2.77	1.22	Ø1.50	1.75	3.50	4.00	4.00	2.00	8.00

SOT-23 Tape Leader and Trailer

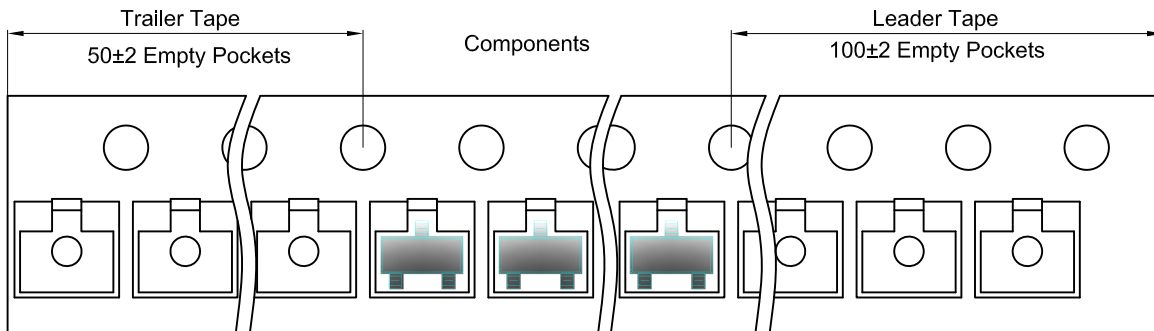

SOT-23 Reel

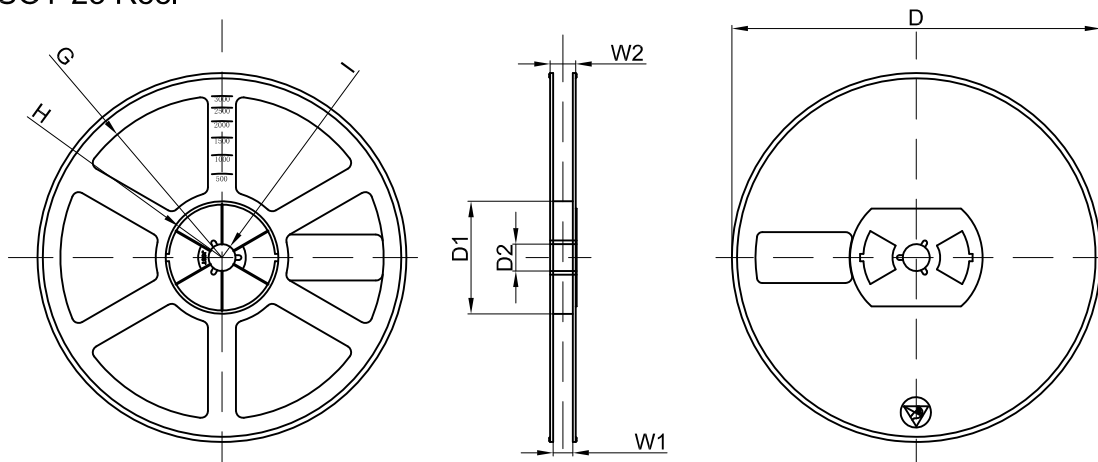

Dimensions are in millimeter								
Reel Option	D	D1	D2	G	H	I	W1	W2
7" Dia	Ø178.00	54.40	13.00	R78.00	R25.60	R6.50	9.50	12.30

REEL	Reel Size	Box	Box Size(mm)	Carton	Carton Size(mm)	G.W.(kg)
3000 pcs	7 Inch	45,000 pcs	203×203×195	180,000 pcs	438×438×220	