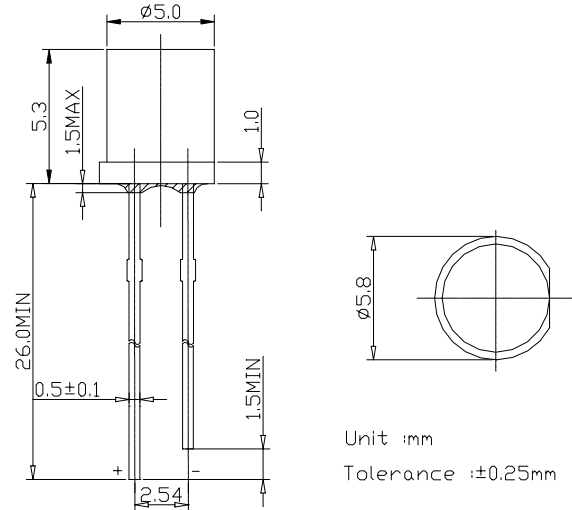

■Features

- 5mm Standard Directivity
- Water clear Type
- Superior Weather-resistance
- UV Resistant Epoxy
- RoHS compliant

■Applications

- Automotive Dashboard Lighting
- Traffic signal lamp
- Back Lighting

■Outline Dimension

■Absolute Maximum Rating

(Ta=25)

Item	Symbol	Value	Unit
DC Forward Current	I_F	50	mA
Pulse Forward Current*	I_{FP}	150	mA
Reverse Voltage	V_R	5	V
Power Dissipation	P_D	200	mW
Operating Temperature	T_{opr}	-30 ~ +85	
Storage Temperature	T_{stg}	-30 ~ +100	
Lead Soldering Temperature	T_{sol}	260 /5sec	-

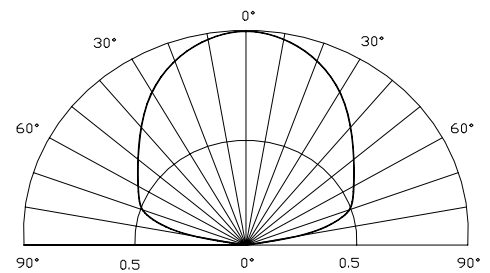
*Pulse width Max.10ms Duty ratio max 1/10

■Directivity

■Electrical -Optical Characteristics

(Ta=25)

Item	Symbol	Condition	Min.	Typ.	Max.	Unit
DC Forward Voltage	V_F	$I_F=20mA$	1.8	2.0	2.4	V
DC Reverse Current	I_R	$V_R=5V$	-	-	10	μA
Domi. Wavelength	λ_D	$I_F=20mA$	620	625	630	nm
Luminous Intensity	I_v	$I_F=20mA$	330	500	750	mcd
50% Power Angle	$2\theta_{1/2}$	$I_F=20mA$	-	140	-	deg