

**■Features**

- High Luminous LEDs
- 3mm Round Standard Directivity
- UV Resistant Epoxy
- Color Diffused Type
- Holder Color: Black

**■Applications**

- Indicate Lamp
- Toys/Games/ Audio
- Other Lighting

**■Outline Dimension**

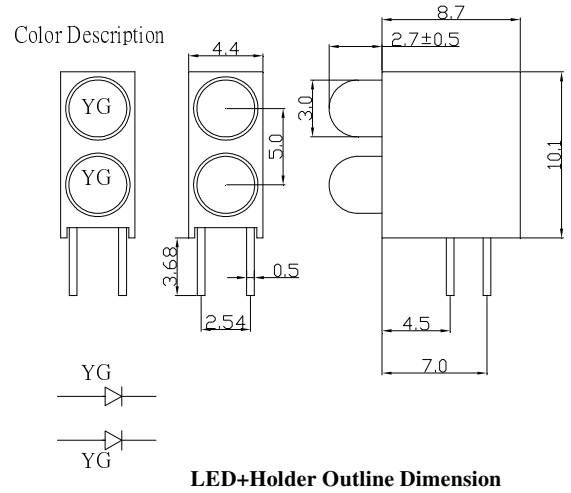
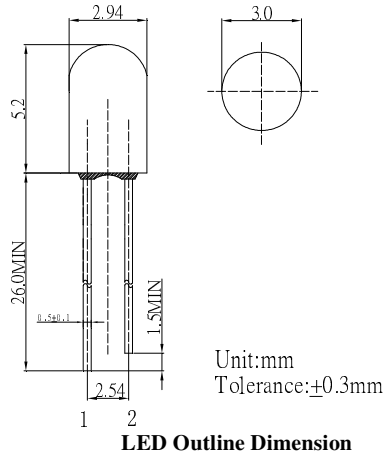

**■Absolute Maximum Rating**

(Ta=25°C)

Item	Symbol	Value	Unit
DC Forward Current	I <sub>F</sub>	30	mA
Pulse Forward Current*	I <sub>FP</sub>	100	mA
Reverse Voltage	V <sub>R</sub>	5	V
Power Dissipation	P <sub>D</sub>	78	mW
Operating Temperature	T <sub>opr</sub>	-30~+85	°C
Storage Temperature	T <sub>stg</sub>	-40 ~ +100	°C
Lead Soldering Temperature	T <sub>sol</sub>	260°C/5sec	-

\*Pulse width Max.10ms Duty ratio max 1/10

**■Directivity**

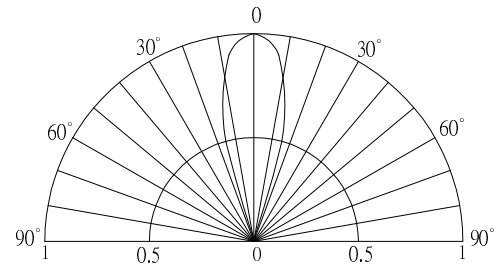

**■Electrical -Optical Characteristics**

(Ta=25°C)

Item	Symbol	Condition	Min.	Typ.	Max.	Unit
DC Forward Voltage	V <sub>F</sub>	I <sub>F</sub> =20mA	1.8	2.1	2.6	V
DC Reverse Current	I <sub>R</sub>	V <sub>R</sub> =5V	-	-	10	μA
Domi. Wavelength	λ <sub>D</sub>	I <sub>F</sub> =20mA	565	570	575	nm
Luminous Intensity	I <sub>v</sub>	I <sub>F</sub> =20mA	40	60	-	mcd
50% Power Angle	2θ <sub>1/2</sub>	I <sub>F</sub> =20mA	-	30	-	deg

\*1 Tolerance of measurements of dominant wavelength is ±1nm

\*2 Tolerance of measurements of luminous intensity is ±15%

\*3 Tolerance of measurements of forward voltage is ±0.1V