

PRODUCT SPECIFICATION

Model No.: FYL-25A3YD1B

Descriptions:
■ Dice material: GaP.
■ Emitting Color: Yellow.
■ Device Outline: 2*5mm square type.
■ Lens Type: Yellow diffused.



CUSTOMER APPROVED SIGNATURES	APPROVED BY	CHECKED BY	PREPARED BY

NINGBO FORYARD OPTOELECTRONICS CO.,LTD.

Add:NO.115 Qixin Road Ningbo Zhejiang China

Zip:315051

Tel: 0086-574-87933652 87927870 87922206

Fax: 0086-574-87927917

E-mail: Sales@foryard.com (General)

[Http://www.foryard.com](http://www.foryard.com)

■ Absolute maximum ratings(Ta=25 ° c)

Parameter	MAX.	Unit
Power Dissipation	75	mW
Peak Forward Current (1/10 Duty Cycle, 0.1ms Pulse Width)	100	mA
Continuous Forward Current	30	mA
Derating Linear From 50°C	0.4	mA/°C
Reverse Voltage	5	V
Operating Temperature Range	-40°C to +85°C	
Storage Temperature Range	-40°C to +100°C	
Lead Soldering Temperature[4mm(.157") From Body]	260°C for 5 Seconds	

■ Electrical and optical characteristics(Ta=25 ° c)

Parameter	Symbol	Min.	Typ.	Max.	Unit	Test Condition
Luminous Intensity	I_v	-	10	-	mcd	$I_F=20mA$
Viewing Angle	$2\theta_{1/2}$	-	130	-	Deg	
Peak Emission Wavelength	λ_p	-	591	-	nm	
Dominant Wavelength	λ_d	585	590	595	nm	
Spectral Line Half-Width	$\Delta\lambda$	-	20	-	nm	
Forward Voltage	V_F	1.7	2.0	2.5	V	
Reverse Current	I_R			10	μA	$V_R=5V$

■ **Typical Electrical Characteristics Curves**
(25 °c Ambient Temperature Unless Otherwise Noted)

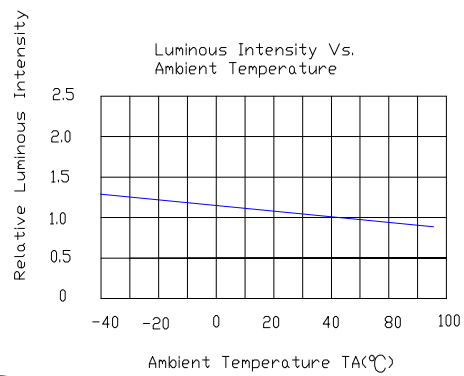
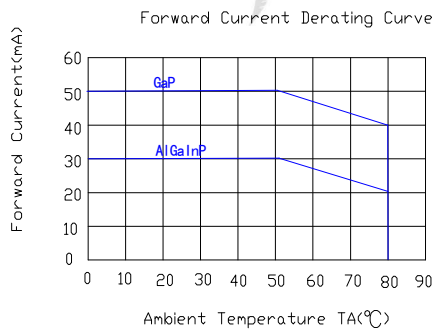
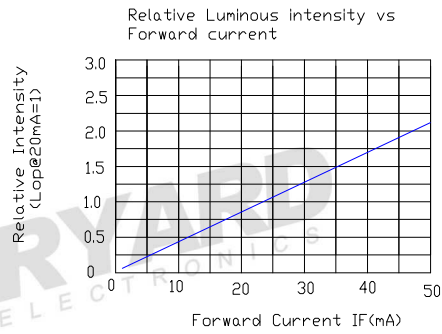
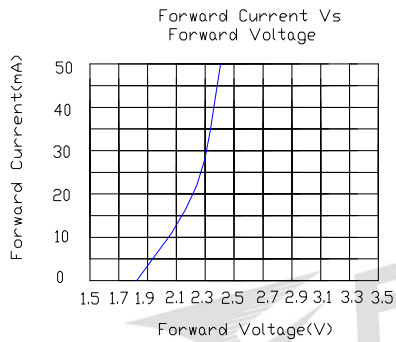
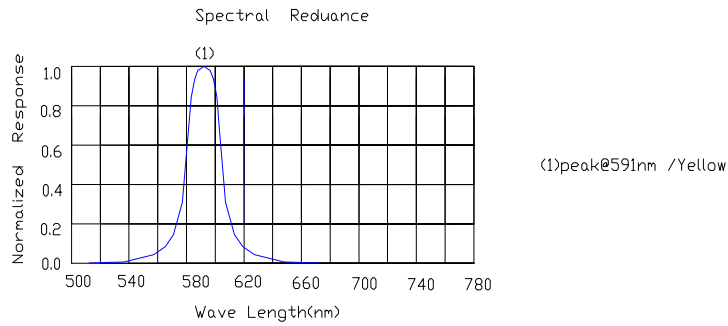

Radiation pattern.

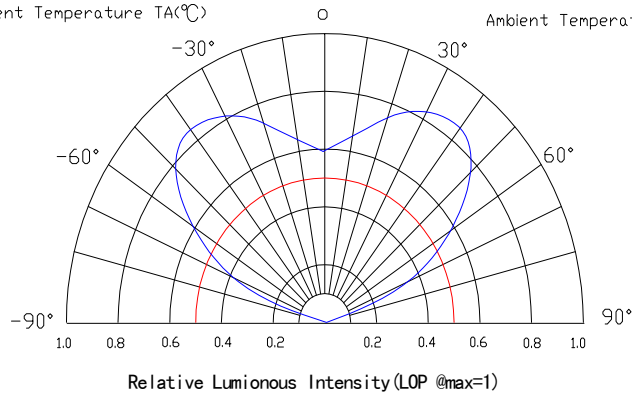

Model No.	FYL-25A3YD1B
Rev.	A

■ LAMP PACKING.

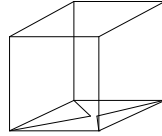
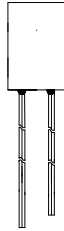

2*5mm 1000PCS/Polybag

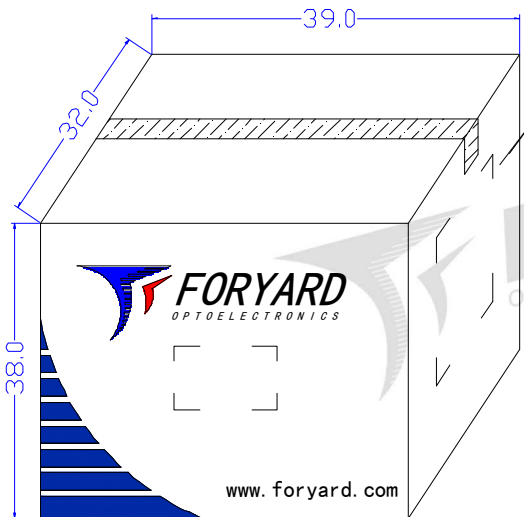
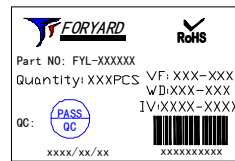

OUTSIDE LABEL

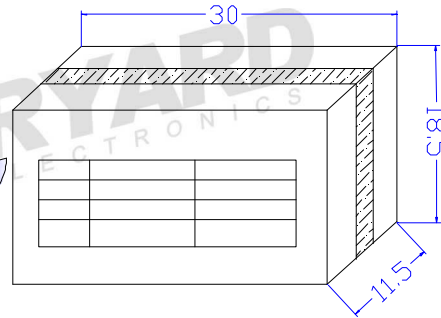

10000PCS/ Box

60000PCS/ Carton



OUTSIDE LABEL