

Characteristics:
 Voltage Rating: 32V
 Current Rating: 20A Max.
 Insulation Resistance: 100MΩ Min. at 500VDC
 Dielectric Strength : AC 500 V Min.at 60s

Material:
 Contact: Brass, T=0.6mm, Tin Plated
 Insulator: Nylon, UL94-V0, Black
 Fuse type: Medium Blade Fuse
 KLS5-270-xxx

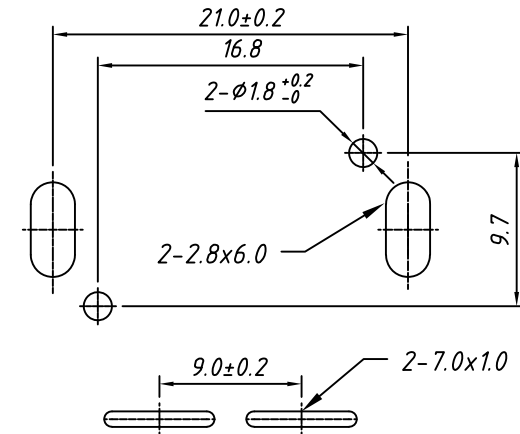
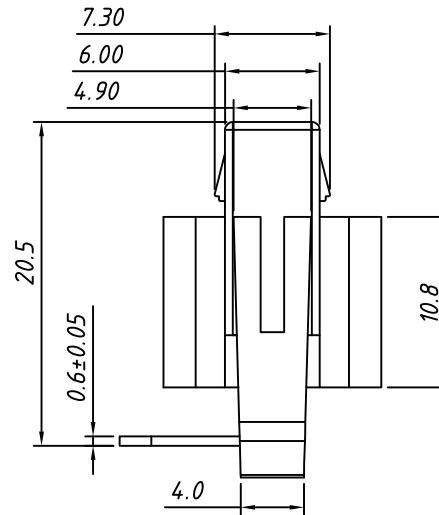
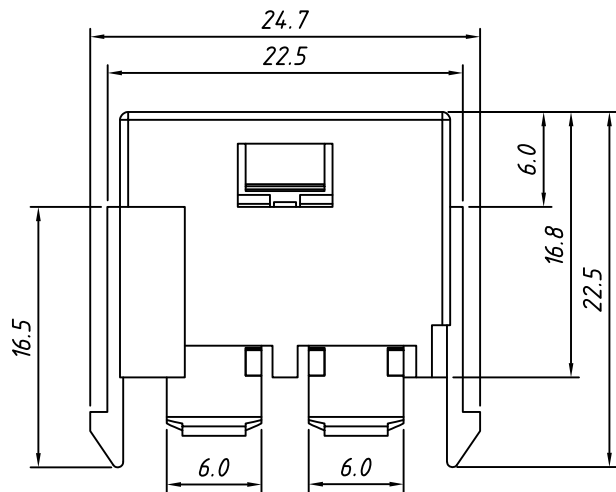

Recommend Mounting Hole

GENERAL TOLERANCE	PROJECTION		Description:
.X ±1.00	UNITS	mm	32V Medium Blade Fuse Holder
.X ±0.50	SCALE	2:1	
.XX ±0.30	Draw by:	Daniel	
ANGLE TOLERANCE	Check by:	Daniel	KLS P/N: L-KLS5-727
±5°	Date	2022-09-01	NingBo KLS ELECTRONIC CO.,L TD.
	SHEET	1 OF 1	