

1W PLCC White Light

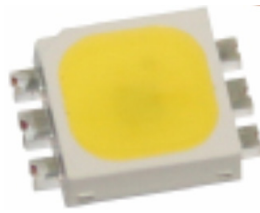

High power PLCC is a surface mount, compact, high brightness LED that is built for various illumination needs. A single Cool White high power PLCC can deliver typical luminous flux of 85 lm while driving at 350mA suitable for any kind of lighting sources, including general illumination, flashlights, streetlights, spotlights, residential lighting, tube light source, freezer lighting, industrial and commercial lightings. The small physical dimension can free customers from any constraints or limitations in these fields of applications. Furthermore, the reflow-solderable nature of high power PLCC provides an easy path towards the optimum thermal management to achieve a promising reliability.

Features

- High luminous Intensity and high efficiency
- Base on InGaN / GaN technology
- Wide viewing angle : 120°
- Excellent performance and visibility
- Suitable for all SMT assembly methods
- IR reflow process compatible
- Environmental friendly; RoHS compliance

Typical Applications

- Signal and symbol luminaire
- Indoor and outdoor displays
- Backlighting (illuminated advertising, general lighting)
- Interior automotive lighting
- Emergency lighting



Table of Contents

PLCC Nomenclature	3
Package Outlines	4
Absolute Maximum Ratings($T_a=25^{\circ}\text{C}$)	4
Electro-Optical Characteristics($T_a=25^{\circ}\text{C}$).....	5
Luminous Flux Characteristics, $I_F=350\text{mA}$	5
Color Temperature or Dominant/Peak Wavelength Characteristics.....	5
V_F Rank($T_a=25^{\circ}\text{C}$).....	6
Luminous Intensity Rank($T_a=25^{\circ}\text{C}$).....	6
CIE Chromaticity Diagram & Color Bin($I_F=350\text{mA/die}$, $T_a=25^{\circ}\text{C}$).....	7
Characteristic Curves	10
PLCC Color Spectrum	10
Reliability Test Item and Condition.....	13
Recommended Reflow Soldering Profile	14
Taping Reel Packaging.....	16
Precaution for Use.....	18

PLCC Nomenclature

E T – 5050 W – B B 1 W
 X1 X2 X3 X4 X5 X6 X7

< Table 1. PLCC Nomenclature >

X1 LED Item		X2 Package Type		X3 Emitting Color		X4 Chip Quantity		X5~X6 Serial No.	X7 Feature	
Code	Type	Code	Type	Code	Type	Code	Type		Code	Type
Edison Top LED	3528	3.5x2.8mm	W	Cool White	1	1pcs			W	White surface
		5050	5.0x5.0mm	H	Neutral White	3	3pcs		B	Black surface
			X	Warm White	A	0.5W		D	Black housing	
			R	Red	B	1W				
			A	Amber (590nm)						
			T	True Green						
			B	Blue						
		RTB	RGB 3 chips							

Package Outlines

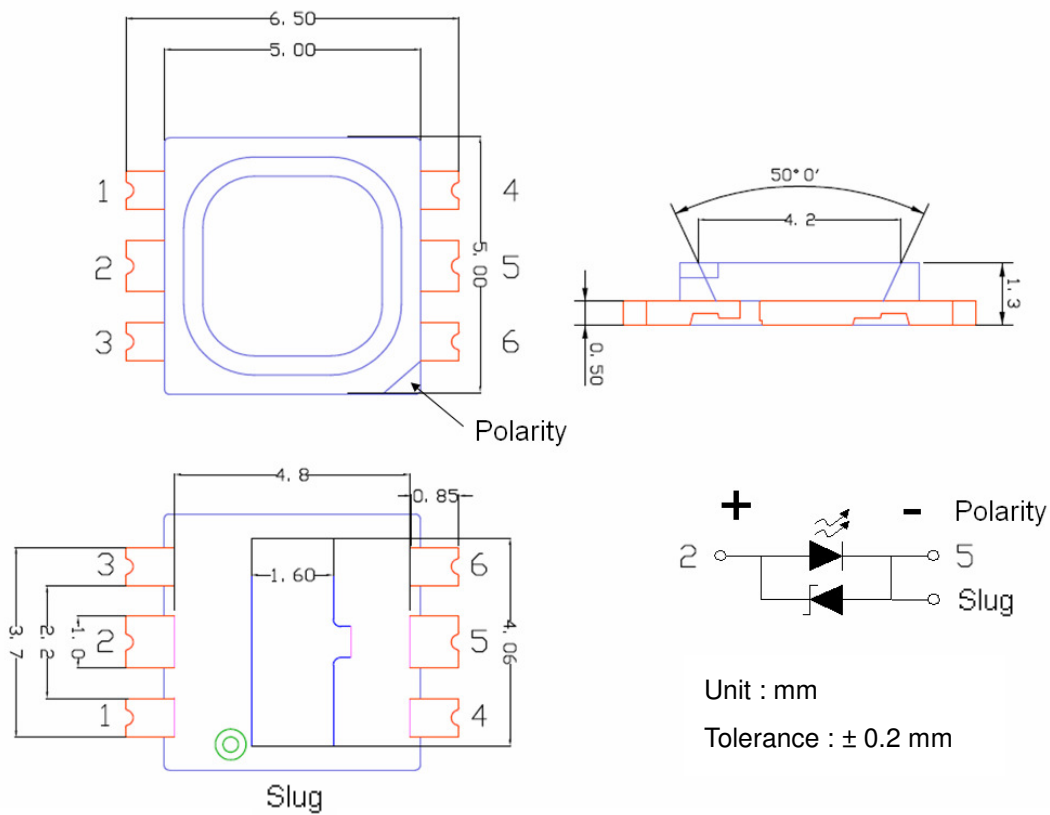

< Figure 1 5050W PLCC Dimension, circuit diagram and recommended soldering pad >

Notes:

1. 1W PLCC slug has polarity as cathode.
2. It is important that the slug can not contact aluminum surface, it is strongly recommended that there should coat a uniform electrically isolated heat dissipation film on the aluminum surface.

Absolute Maximum Ratings($T_a=25^{\circ}\text{C}$)

< Table 2. PLCC Absolute maximum ratings >

Parameter	Symbol	Value	Unit
Forward Current	I_F	350	mA
Pulse Forward Current	I_{FP}^*	1000	mA
Reverse Voltage	V_R	5	V
LED Junction Temperature	T_J	125	$^{\circ}\text{C}$
Operating Temperature	T_{op}	-30 ~ +85	$^{\circ}\text{C}$
Storage Temperature	T_{stg}	-40 ~ +120	$^{\circ}\text{C}$
ESD Sensitivity	V_B	2,000	V
Soldering Temperature	T_{sld}	Reflow Soldering : 255~260 $^{\circ}\text{C}$ /10~30sec Manual Soldering : 350 $^{\circ}\text{C}$ /3sec	

Notes:

1. The values are based on 1-die performance.
- 2.* I_{FP} condition: pulse width ≤ 0.1 msec and duty $\leq 1/10$.

Electro-Optical Characteristics($T_a=25^{\circ}\text{C}$)

< Table 3. PLCC Electro-optical characteristics >

Parameter	Symbol	Condition	Min	Typ	Max	Unit
Forward Voltage	V_F	$I_F=350\text{mA/die}$	2.8	-	3.8	V
Reverse Current	I_R	$V_R=5\text{V}$	-	-	10	μA
Viewing Angle	$2\theta_{1/2}^*$	$I_F=350\text{mA/die}$	-	120	-	deg.

Note:

$2\theta_{1/2}$ is the off-axis angle where the luminous intensity is half of the axial luminous intensity.

Luminous Flux Characteristics, $I_F=350mA$:

< Table 4. PLCC Luminous Flux characteristics. >

Power Consumption	Part Name	Color	Flux			Units
			Min.	Typ.	Max.	
1W	ET-5050W-BB1W	Cool White	--	85	--	lm
	ET-5050H-BE1W	Neutral White	--	75	--	lm
	ET-5050X-BE1W	Warm White	--	65	--	lm

Color Temperature or Dominant/Peak Wavelength Characteristics, $T_a=25^\circ C$ at 350mA :

< Table 5. PLCC color temperature or dominant/peak wavelength characteristics. >

Power Consumption	Part Name	Color	CCT/Wavelength			Units
			Min.	Typ.	Max.	
1W	ET-5050W-BB1W	Cool White	5,000	--	10,000	K
	ET-5050H-BE1W	Neutral White	3,800	--	50,00	K
	ET-5050X-BE1W	Warm White	2,670	--	3,800	K

Color Temperature Characteristics $T_J=25^\circ C$ at 350mA :

< Table 6 Color Rendering Index Characteristics at $T_J=25^\circ C$ for High Power PLCC series >

Part Name	Color	CRI
		Typ
ET-5050W-BB1W	Cool White	70
ET-5050H-BE1W	Neutral White	75
ET-5050X-BE1W	Warm White	80

Note:

1. CRI is measured with an accuracy of ± 5

V_F Rank(T_a=25°C)

< Table 7. PLCC forward voltage rank >

Cool White, Neutral White& Warm White

V _F (V)			
V01	2.8 – 3.1	V04	3.7 – 4.0
V02	3.1 – 3.4	V05	4.0 – 4.3
V03	3.4 – 3.7	V06	4.3 – 4.6

Note:

* Forward voltage measurement allowance is ± 0.1V.

Luminous Intensity Rank(T_a=25°C)

<Table 8.Luminous intensity rank >

Group	Min.	Max.
G	3.7	4.8
H	4.8	6.3
J	6.3	8.2
K	8.2	10.6
L	10.6	13.8
M	13.8	17.9
N	17.9	23.3
P	23.3	30.3
Q	30.3	39.4
R	39.4	51.2
S1	51.2	58.8
S2	58.8	66.5
T1	66.5	70
T2	70	80
T3	80	86.5
U1	86.5	90
U2	90	100
U3	100	112.5
V	112.5	146.2
W	146.2	190
X	190	247.1
Y	247.1	321.2
Z	321.2	417.5

Note:

Luminous Intensity Measurement Allowance is ± 10%.

Color Bin ($I_F=350\text{mA/die}$, $T_a=25^\circ\text{C}$)

< Table 9. Color Bin V0-Y4 >

	x	y		x	y		x	y		x	y
V0	0.3434	0.3320	W1	0.3294	0.3202	X1	0.3076	0.3108	Y1	0.3040	0.2850
	0.3425	0.3208		0.3295	0.3105		0.3174	0.3204		0.2990	0.3010
	0.3295	0.3105		0.3196	0.3013		0.3196	0.3013		0.3076	0.3108
	0.3294	0.3200		0.3186	0.3102		0.3112	0.2932		0.3112	0.2932
V1	0.3292	0.3313	W2	0.3292	0.3313	X2	0.3076	0.3108	Y2	0.2990	0.3010
	0.3444	0.3442		0.3294	0.3202		0.3052	0.3224		0.2920	0.3210
	0.3434	0.3320		0.3186	0.3102		0.3160	0.3332		0.3031	0.3327
	0.3294	0.3200		0.3175	0.3204		0.3175	0.3204		0.3076	0.3108
V2	0.3292	0.3313	W3	0.3290	0.3451	X3	0.3052	0.3224	Y3	0.3040	0.2850
	0.3290	0.3451		0.3292	0.3313		0.3031	0.3327		0.2899	0.2703
	0.3458	0.3592		0.3175	0.3204		0.3148	0.3444		0.2830	0.2838
	0.3444	0.3442		0.3160	0.3332		0.3160	0.3332		0.2990	0.3010
V3	0.3290	0.3451	W4	0.3290	0.3451	X4	0.3031	0.3327	Y4	0.2990	0.3010
	0.3288	0.3569		0.3160	0.3332		0.3011	0.3422		0.2830	0.2838
	0.3469	0.3717		0.3148	0.3444		0.3136	0.3550		0.2742	0.3007
	0.3458	0.3592		0.3288	0.3569		0.3148	0.3444		0.2920	0.3210
V4	0.3288	0.3569	W5	0.3148	0.3444						
	0.3286	0.3690		0.3136	0.3550						
	0.3481	0.3856		0.3286	0.3690						
	0.3469	0.3717		0.3288	0.3569						

Note:

Color coordinates measurement allowance is ± 0.01

CIE Chromaticity Diagram

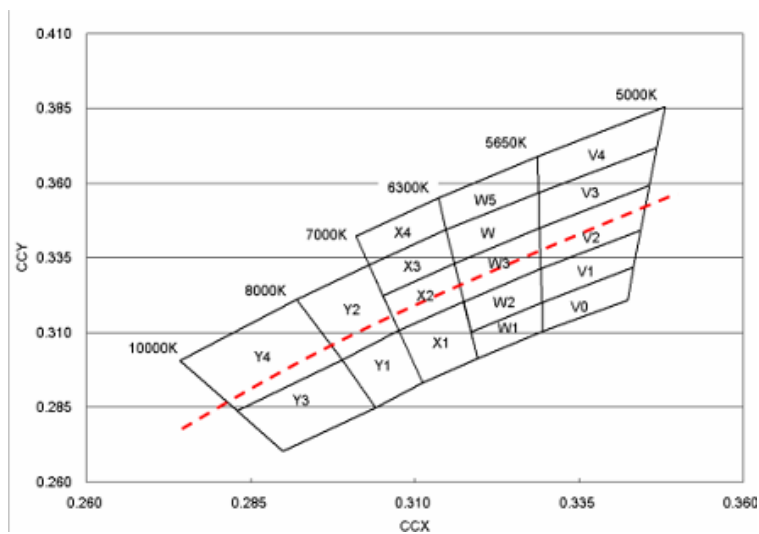

< Figure 2 PLCC Chromaticity diagram >

Color Bin ($I_F=350\text{mA/die}$, $T_a=25^\circ\text{C}$)

< Table 10. Color Bin M0-R4 >

	x	y		x	y		x	y		x	y		x	y
M0	0.4370	0.3840	N0	0.4356	0.3837	P0	0.4220	0.3790	Q0	0.4100	0.3740	R0	0.3966	0.3673
	0.4490	0.3875		0.4280	0.3700		0.4150	0.3635		0.4035	0.3580		0.3917	0.3530
	0.4420	0.3750		0.4150	0.3635		0.4035	0.3580		0.3917	0.3530		0.3785	0.3460
	0.4280	0.3700		0.4220	0.3790		0.4100	0.3740		0.3966	0.3673		0.3826	0.3595
M1	0.4436	0.3991	N1	0.4294	0.3943	P1	0.4294	0.3943	Q1	0.4165	0.3890	R1	0.3871	0.3739
	0.4577	0.4029		0.4436	0.3991		0.4221	0.3790		0.4100	0.3738		0.4021	0.3822
	0.4490	0.3875		0.4356	0.3837		0.4150	0.3738		0.4100	0.3738		0.3966	0.3673
	0.4356	0.3837		0.4221	0.3790		0.4165	0.3890		0.3966	0.3673		0.3826	0.3595
M2	0.4525	0.4162	N2	0.4525	0.4162	P2	0.4240	0.4065	Q2	0.4086	0.3995	R2	0.4086	0.3995
	0.4671	0.4196		0.4436	0.3991		0.4376	0.4116		0.4240	0.4065		0.4021	0.3822
	0.4577	0.4029		0.4294	0.3943		0.4294	0.3943		0.4165	0.3890		0.3871	0.3739
	0.4436	0.3991		0.4376	0.4116		0.4165	0.3890		0.4021	0.3822		0.3924	0.3909
M3	0.4614	0.4333	N3	0.4614	0.4333	P3	0.4312	0.4234	Q3	0.4086	0.3995	R3	0.4086	0.3995
	0.4767	0.4366		0.4525	0.4162		0.4456	0.4287		0.4148	0.4161		0.3924	0.3909
	0.4671	0.4196		0.4376	0.4116		0.4376	0.4116		0.4312	0.4234		0.3963	0.4035
	0.4525	0.4162		0.4456	0.4287		0.4240	0.4065		0.4240	0.4065		0.4148	0.4161
M4	0.4705	0.4508	N4	0.4538	0.4460	P4	0.4385	0.4404	Q4	0.4385	0.4404	R4	0.4023	0.4228
	0.4866	0.4542		0.4705	0.4508		0.4538	0.4460		0.4312	0.4234		0.4209	0.4326
	0.4767	0.4366		0.4614	0.4333		0.4456	0.4287		0.4148	0.4161		0.4148	0.4161
	0.4614	0.4333		0.4456	0.4287		0.4312	0.4234		0.4209	0.4326		0.3963	0.4035

Note:

Color coordinates measurement allowance is ± 0.01

CIE Chromaticity Diagram

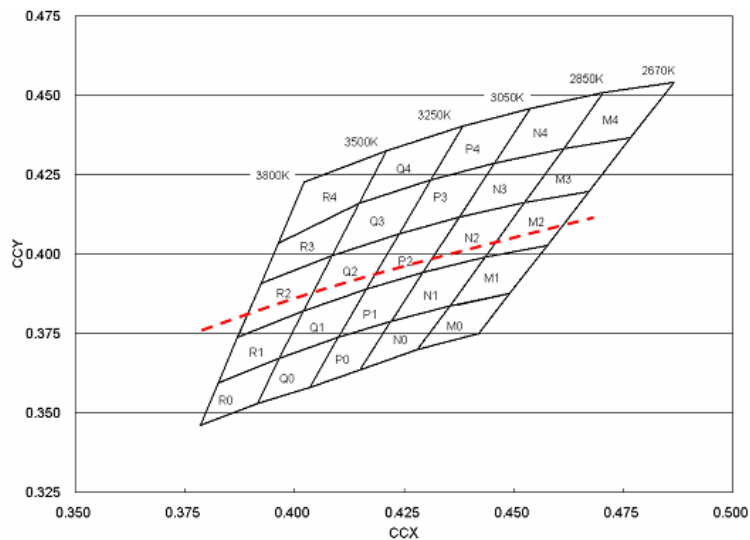

< Figure 3 PLCC Chromaticity diagram >

Color Bin ($I_F=350mA/die, T_a=25^\circ C$)

< Table 11. Color Bin S0-U4 >

	x	y		x	y		x	y
S0	0.3826	0.3595	T0	0.3706	0.3520	U0	0.3571	0.3426
	0.3785	0.3460		0.3670	0.3377		0.3548	0.3290
	0.3670	0.3377		0.3548	0.3290		0.3425	0.3208
	0.3706	0.3520		0.3571	0.3426		0.3434	0.3320
S1	0.3741	0.3658	T1	0.3741	0.3658	U1	0.3594	0.3557
	0.3871	0.3739		0.3706	0.3520		0.3571	0.3426
	0.3826	0.3595		0.3571	0.3426		0.3434	0.3320
	0.3706	0.3520		0.3594	0.3557		0.3444	0.3442
S2	0.3783	0.3825	T2	0.3622	0.3716	U2	0.3622	0.3716
	0.3924	0.3909		0.3783	0.3825		0.3594	0.3557
	0.3871	0.3739		0.3741	0.3658		0.3444	0.3442
	0.3741	0.3658		0.3594	0.3557		0.3458	0.3592
S3	0.3783	0.3825	T3	0.3642	0.3829	U3	0.3642	0.3829
	0.3811	0.3937		0.3811	0.3937		0.3622	0.3716
	0.3963	0.4035		0.3783	0.3825		0.3458	0.3592
	0.3924	0.3909		0.3622	0.3716		0.3469	0.3717
S4	0.3860	0.4130	T4	0.3673	0.4003	U4	0.3469	0.3717
	0.4023	0.4228		0.3860	0.4130		0.3481	0.3856
	0.3963	0.4035		0.3811	0.3937		0.3673	0.4003
	0.3811	0.3937		0.3642	0.3829		0.3642	0.3829

Note:
Color coordinates measurement allowance is ± 0.01

CIE Chromaticity Diagram

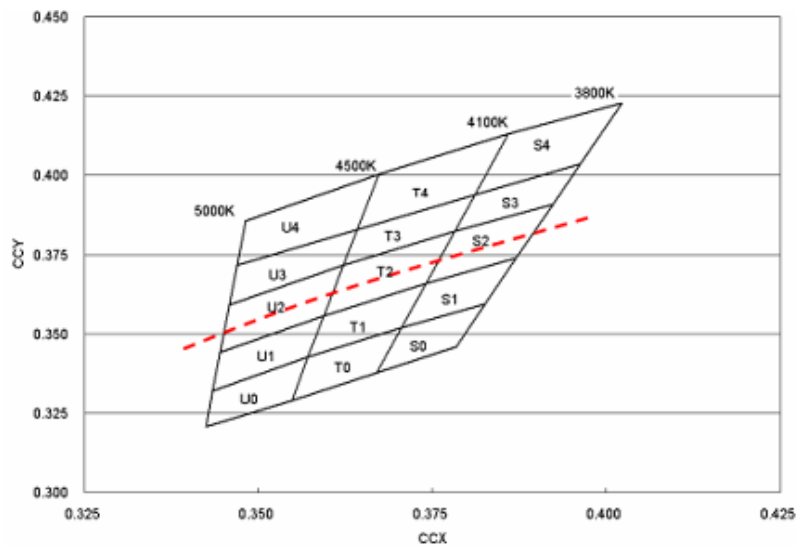

< Figure 4 PLCC Chromaticity diagram >

Characteristic Curves

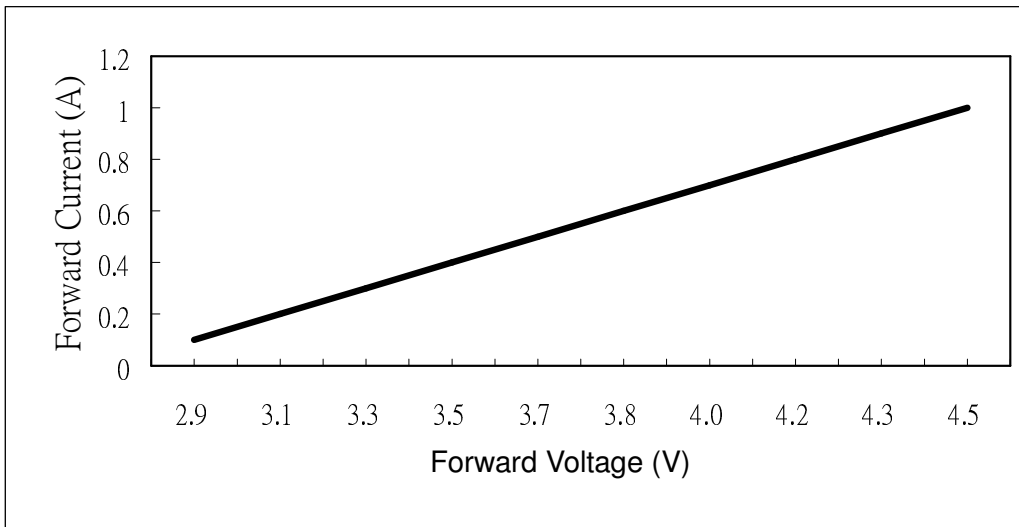

< Figure 5. Forward current & forward voltage for 1W PLCC >

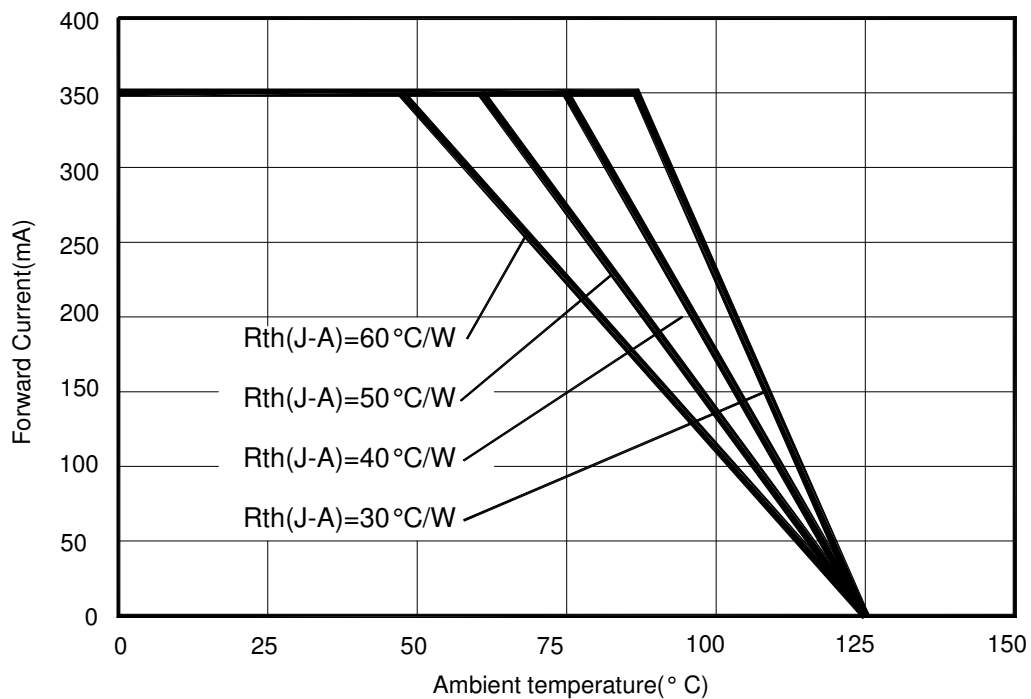

< Figure 6. Operating current & ambient temperature for 1W PLCC >

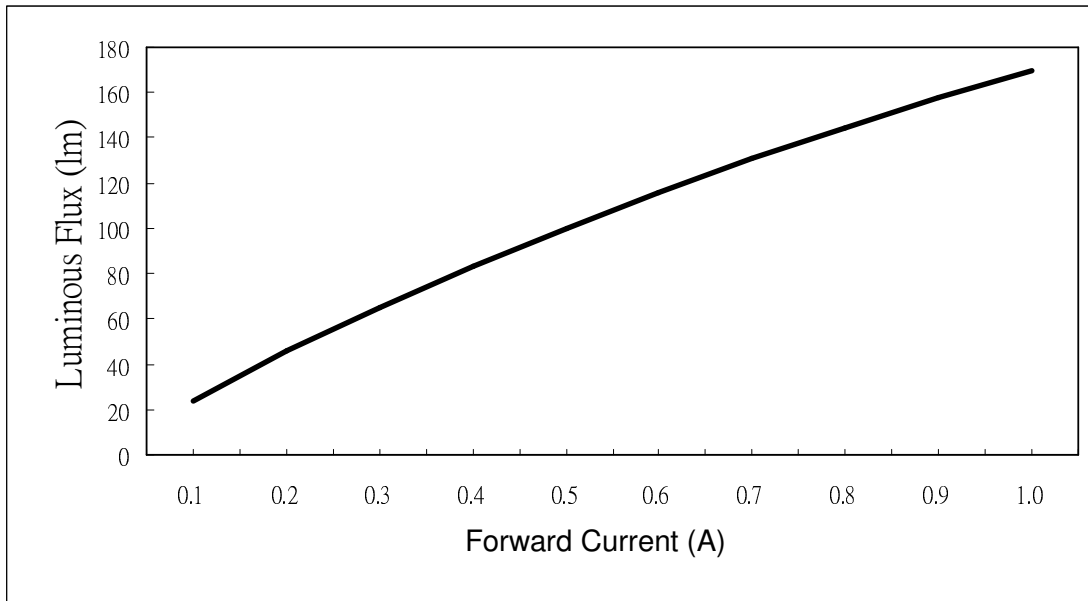

< Figure 7. Forward current & relative luminous at $T_a=25^\circ\text{C}$ for 1W PLCC >

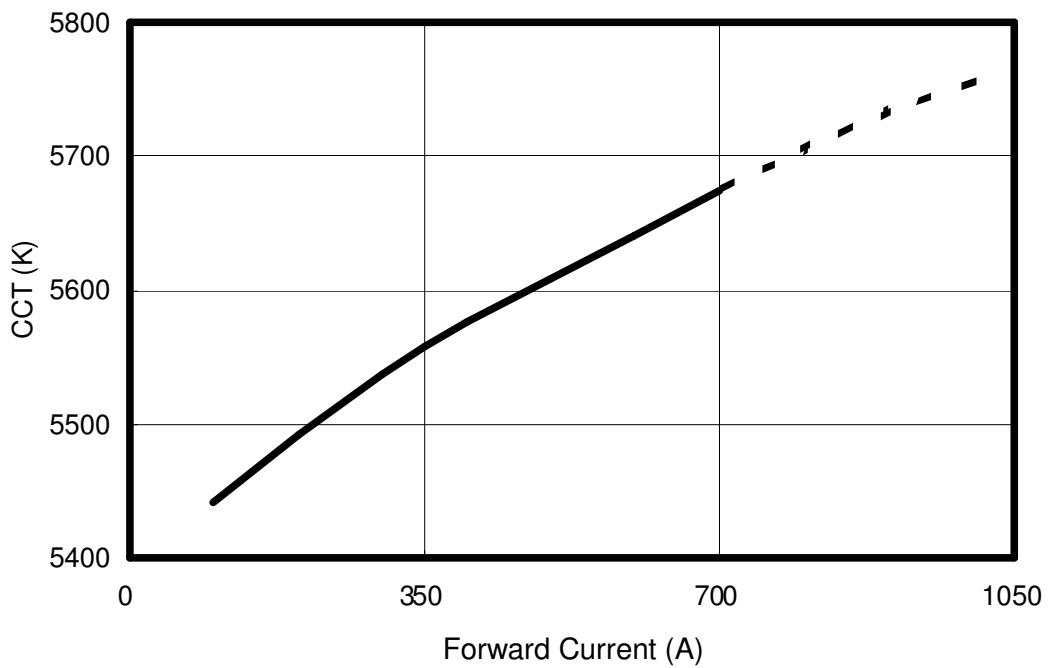

< Figure 8. Forward current & CCT at $T_a=25^\circ\text{C}$ for PLCC Cool White >

PLCC Color Spectrum, $T_a = 25^\circ\text{C}$:

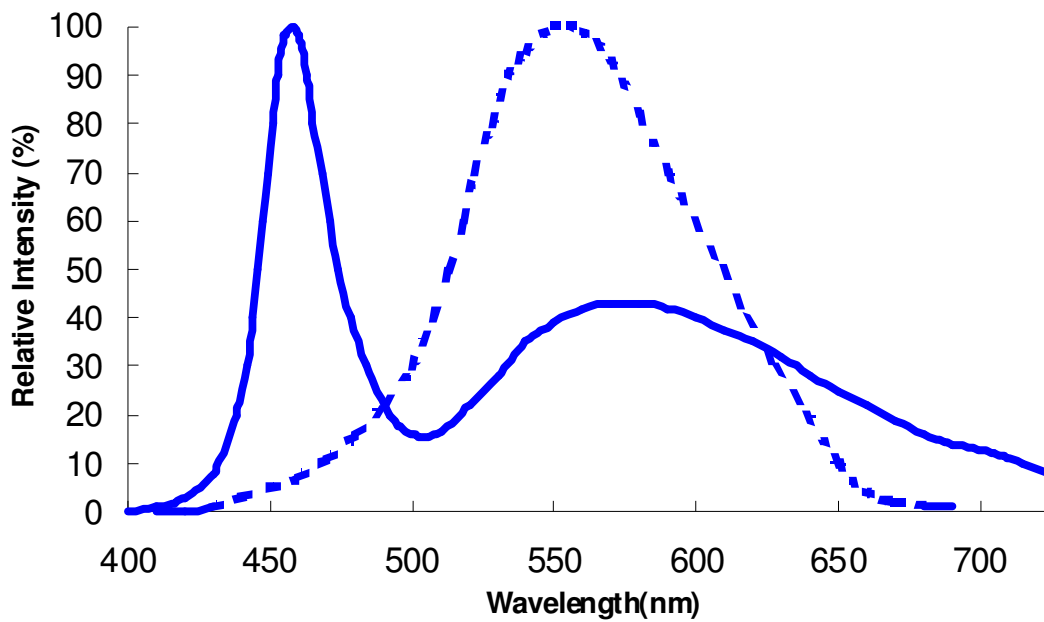

<Figure 9: Color Spectrum for Cool White at a typical CCT. Dotted curve represents the standard eye response, $T_a=25^\circ\text{C}$.>

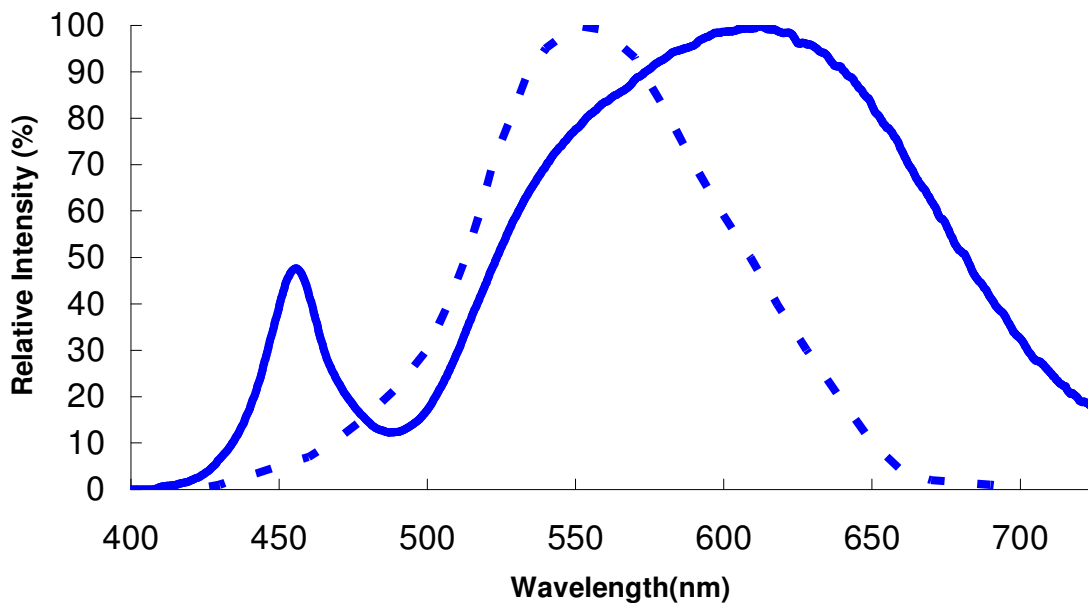

<Figure 10: Color Spectrum for Neutral White and Warm White at a typical CCT. Dotted curve represents the standard eye response, $T_a=25^\circ\text{C}$.>

Thermal Resistance – Junction to Thermal Pad:

< Table 12.Thermal Resistance >

Thermal Resistance from Junction to Thermal Pad	Units
10	°C / W

Reliability Test Item and Condition

< Table 13.Test items >

Stress Test	Stress Conditions	Stress Duration	Failure Criteria
IR reflow	Peak temp.=255~260°C 10sec (Pre treatment 60°C/60%RH,168hrs)	3 times	No catastrophic
Room Temperature Operating Life	25 °C, I _F =DC max ^[1]	1000 hours	Note 2
High Temperature High Humidity Operating Life	85 °C / 85%RH, I _F = 150mA	1000 hours	Note 2
High Temperature Operating Life	85 °C, I _F =150mA	1000 hours	Note 2
Low Temperature Operating Life	-40 °C, I _F =DC max ^[1]	1000 hours	Note 2
High Temperature Storage Life	150 °C	1000 hours	Note 2
Low Temperature Storage Life	-40 °C	1000 hours	Note 2
Non-Operating Thermal Shock	-40 / 125°C, 20 min dwell < 10 sec transfer	300 cycles	No catastrophic

Notes:

1. DC max is defined to be 350mA for 1W PLCC.
2. Failure Criteria:
 - Electrical failures: V_F shifts >= 10%
 - Light Output Degradation: Percentage level shift >= 50% at 1,000hrs or 500cycle
 - Visual failures: Broken or damaged package on lens or substrate
3. The IR reflow test can pass through JEDEC level 2a criterion.

Recommended Reflow Soldering Profile

The following reflow profile is from IPC/JEDEC J-STD-020D which provided here for reference.

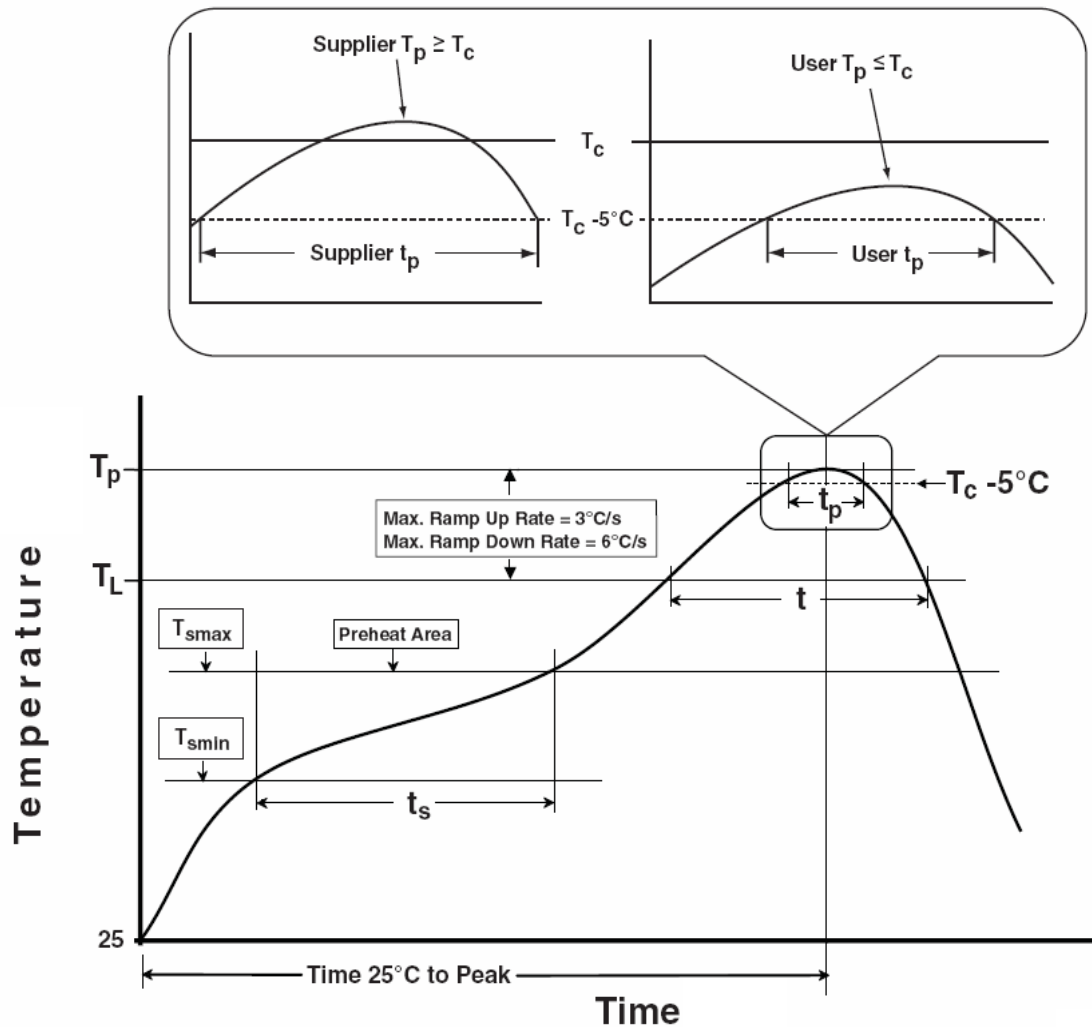

< Figure 11 Time-temperature of JEDEC J-STD-020D >

< Table 14.Classification reflow profile>

Profile Feature	Sn-Pb Eutectic Assembly	Pb-Free Assembly
Preheat & soak Temperature min (T _{min}) Temperature max (T _{max}) Time (T _{min} to T _{max}) (ts)	100 °C 150 °C 60-120 seconds	150 °C 200 °C 60-120 seconds
Average ramp-up rate (T _{max} to T _p)	3 °C/second max.	3 °C/second max.
Liquidous temperature (TL) Time at liquidous (tL)	183 °C 60-150 seconds	217 °C 60-150 seconds
Peak package body temperature (T _p)*	230 °C ~235 °C *	255 °C ~260 °C *
Classification temperature (T _c)	235 °C	260 °C
Time (t _p)** within 5 °C of the specified classification temperature (T _c)	20** seconds	30** seconds
Average ramp-down rate (T _p to T _{max})	6 °C/second max.	6 °C/second max.
Time 25 °C to peak temperature	6 minutes max.	8 minutes max.

Notes:

- 1.* Tolerance for peak profile temperature (T_p) is defined as a supplier minimum and a user maximum.
- 2.** Tolerance for time at peak profile temperature (t_p) is defined as a supplier minimum and a user maximum.

1. Soldering conditions

- Reflow soldering should not be done more than twice.
- When soldering, do not put stress on the LEDs during heating.
- After soldering, do not warp the circuit board.
- Repair should not be done after the LEDs have been soldered. When repair is unavoidable, a double-head soldering iron should be used. It should be confirmed beforehand whether the characteristics of the LEDs will be damaged by repairing or not.
- The encapsulated material of the LEDs is silicone. Therefore precautions should be taken to avoid the strong pressure on the encapsulated part.

2. Cleaning

- It is recommended to use isopropyl alcohol as a solvent to clean the LEDs. When using other solvents, it should be confirmed beforehand whether the solvents will dissolve the package and the resin or not.

Taping Reel Packaging

1. Taping Reel

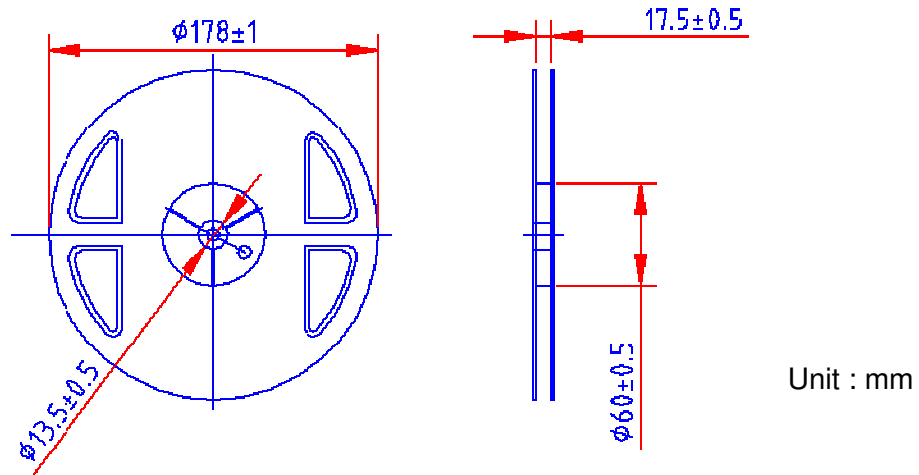

1. Common dimensions.

Item	Specification	Tol. (+/-)
W	16.00	± 0.30
E	1.75	± 0.10
F	7.50	± 0.10
D0	1.50	± 0.10
D1	1.50	± 0.10
P0	4.00	± 0.10
P1	8.00	± 0.10
P2	2.00	± 0.10
P0 x10	40.00	± 0.20

2. Pocket & other dimensions.

Item	Specification	Tol. (+/-)
t	0.30	± 0.05
A0	5.30	± 0.10
B0	7.50	± 0.10
K0	1.60	± 0.10
A1		
B1		
K1		

3. Drawing. (Conform to EIA-481 standard)

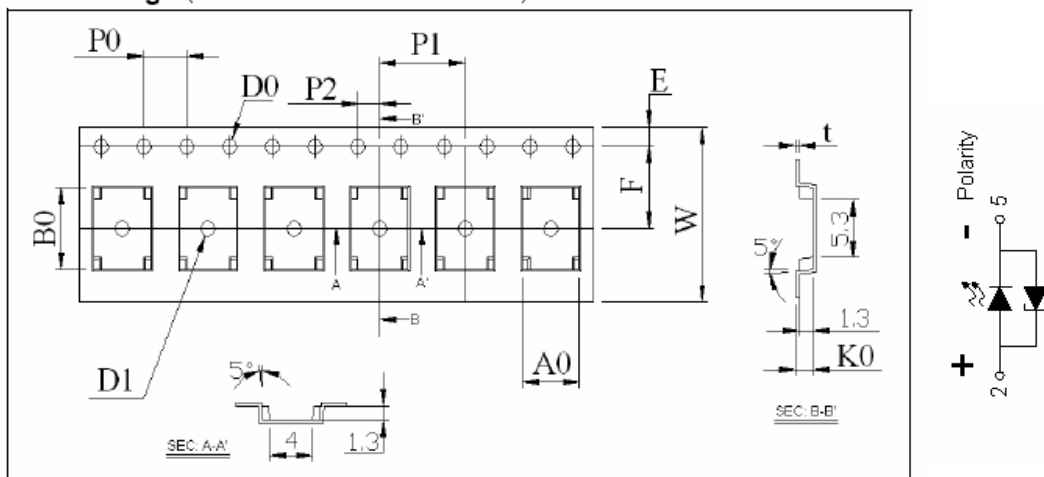

< Figure 12 Taping reel dimension >

2. Packaging

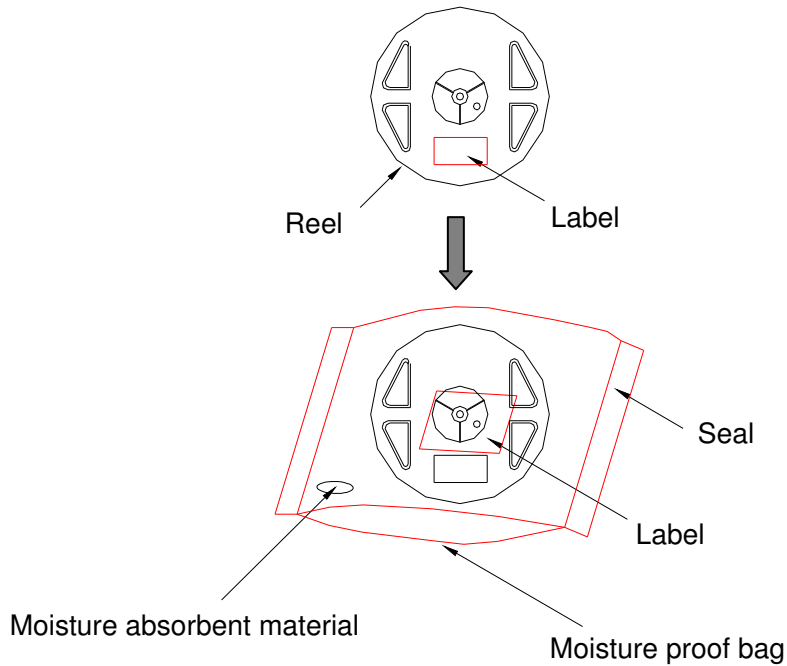

< Figure 13 Packaging diagram >

3. Package Label

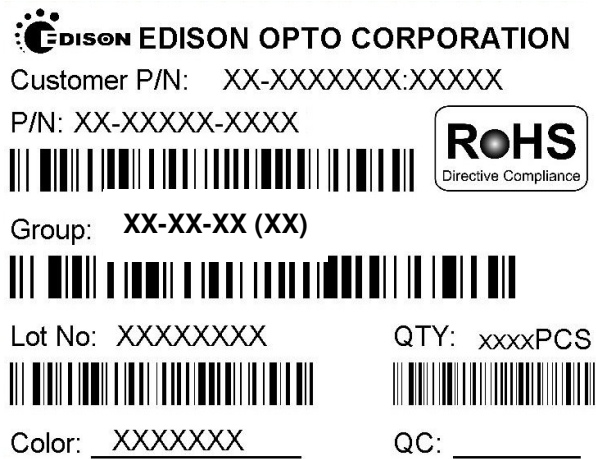

< Figure 14 Package label >

< Table 15 Package dimensions and quantity >

Item	Quantity	Total	Dimensions(mm)
Reel	1,000pcs	1,000pcs	Diameter=178
Inner box	3 reels	3,000pcs	240*235*67mm
Outer box	10 inner boxes	30,000pcs	500*260*355mm

Precaution for Use

1. Storage

1.1 Before opening the package

- The LEDs should be kept at $<40^{\circ}\text{C}$ & $<90\%RH$. The LEDs should be used within a year. When storing the LEDs, moisture proof package with absorbent material (silica gel) is recommended.

1.2 opening the package

- The LEDs should be kept at $\leq 30^{\circ}\text{C}$ & $\leq 60\%RH$. The LEDs should be soldered within 168 hours (7days) after opening the moisture proof package.
- If unused LEDs remain, they should be stored in moisture proof packages, such as sealed containers with moisture proof package within absorbent material (silica gel). It is also recommended to return the unused LEDs to the original moisture proof package and to seal the moisture proof package again.
- If the moisture absorbent material (silica gel) vapors or expires the expiration date, baking treatment should be performed by using the following conditions : 60°C for 20 hours.
- The LEDs electrode and leadframe comprise a silver plated copper alloy. The silver surface may be affected by environments. Please avoid conditions which may cause the LEDs being corroded or discolored. The corrosion or discoloration might lower solderability or affect optical characteristics.
- Please avoid rapid transition in ambient temperature, especially in high humidity environments where condensation can occur.

2. Static electricity

- The products are sensitive to static electricity and highly taken care when handling them.
- Static electricity or surge voltage will damage the LEDs. It is recommended to wear an anti-electrostatic wristband or an anti-electrostatic glove when handling the LEDs.
- All devices, equipments and machinery must be properly grounded. It is recommended that measures be taken against surge voltage to the equipment that mounts the LEDs.

Notes:

- 1.All the information published is considered to be reliable. However, EDISON OPTO does not assume any liability arising out of the application or use of any product described herein.
- 2.EDISON OPTO reserves the right to make changes at any time without notice to any products in order to improve reliability, function or design.
- 3.EDISON OPTO products are not authorized for use as critical components in life support devices or systems without the express written approval from the managing director of EDISON OPTO.