





APPROVAL Electrical		
Standard	UL	IEC
Rated voltage	300V	250V
Rated current	15A	24A
Wire range	24-14AWG	0.5-2.5mm ²
Withstanding voltage	AC2000V/1Min	
Menchanical		
Torque	0.5Nm(4.4Lb-In)	
Ambient temperature	-40°C~+105 °C	
Strip length	7mm	
Dimensions		
pitch	5.0mm(.197") 5.08mm(.200")	
Poles	2P,3P-24P	
Material		
Housing	PA66,UL94V-0	
Screws	M3,Steel, C ³⁺ Znplated	
Pin header	Brass,Tin plated	
Cage	Brass,Ni plated	



HOW TO ORDER :

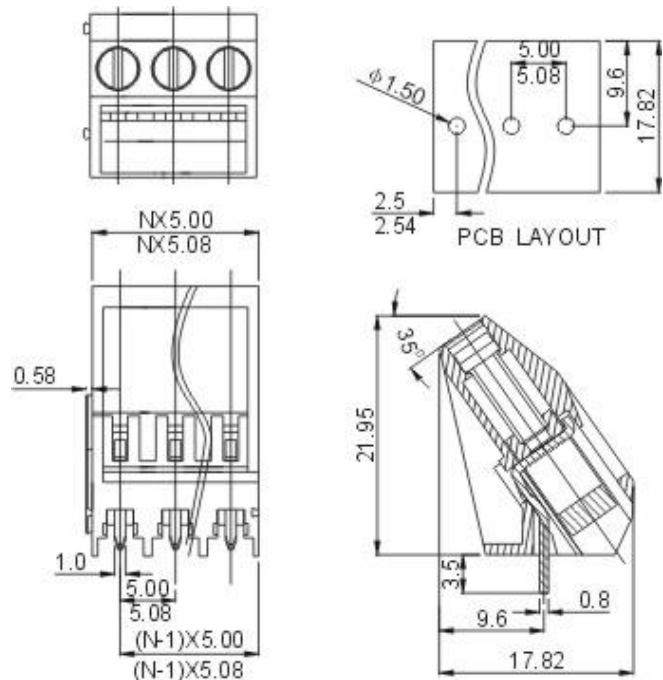
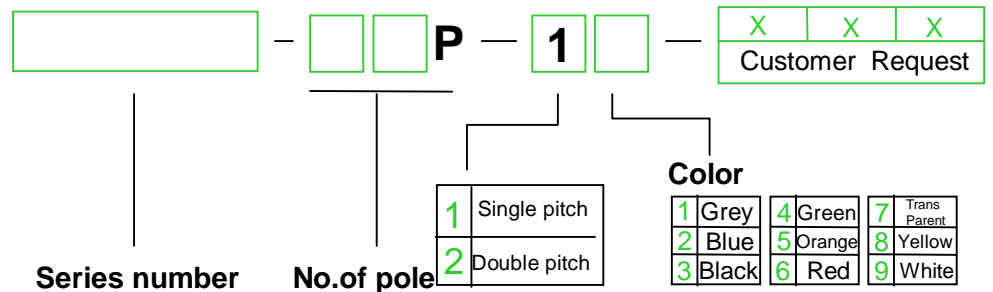
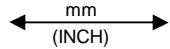

	 DEGSON ELECTRONICS CO., LTD.
	NAME DG104-5.0 DG104-5.08