

INFRARED RECEIVER MODULE

● Description

1. The BRM-1020 is miniaturized infrared receivers for remote control and other applications requiring improved ambient light rejection.
2. The separate PIN diode and preamplifier IC are assembled on a single leadframe.
3. The epoxy package contains a special IR filter.
4. This module has excellent performance even in disturbed ambient light applications and provides protection against uncontrolled output pulses.

● Features

1. Photo detector and preamplifier in one package .
2. Internal filter for PCM frequency.
3. High immunity against ambient light.
4. Improved shielding against electric field disturbance.
5. 3.0V or 5.0V supply voltage; low power consumption.
6. TTL and CMOS compatibility.
7. Suitable transmission code:NEC code,RC5 code.
8. This product doesn't contain restriction substance, comply ROHS standard

● Applications:

1. It can be used for TVs 、VTRs 、 audio equipment air conditioners 、 car stereo radio 、 toys 、 home computers and all other equipment requiring remote control.

● BLOCK DIAGRAM

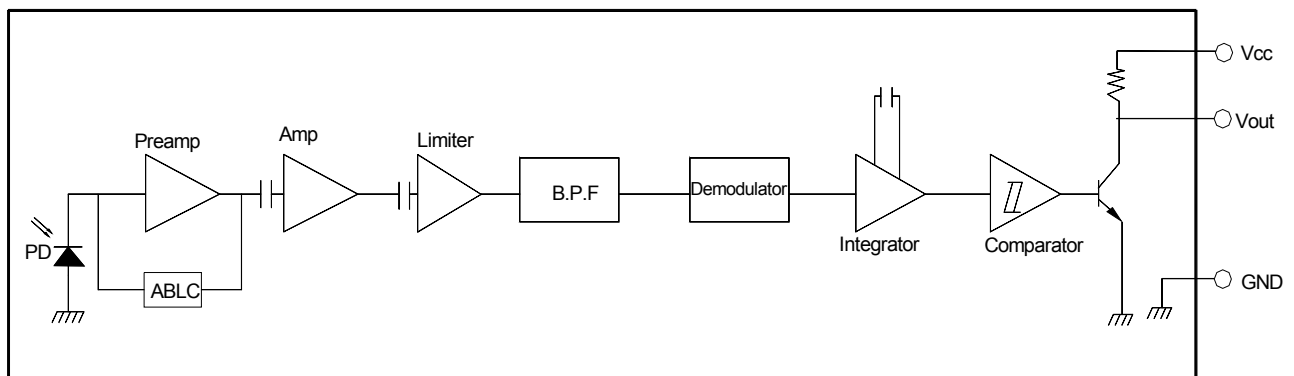

● Package Dimensions:

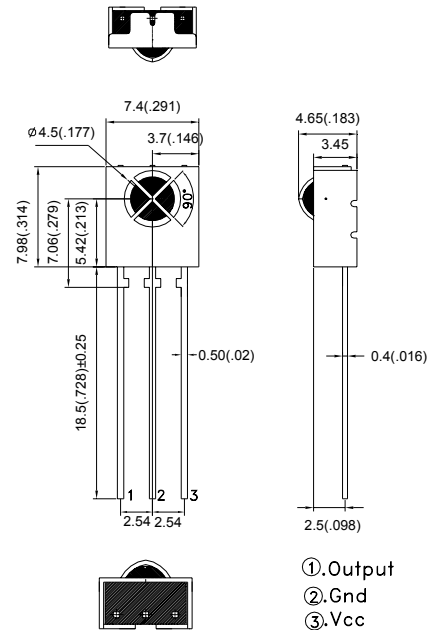

NOTES:

- 1.All dimensions are in millimeters (inches).
- 2.Tolerance is $\pm 0.10\text{mm}$ (0.004") unless otherwise specified.
- 3.Specifications are subject to change without notice.

● **Absolute Maximum Ratings**($T_a=25^{\circ}\text{C}$)

Parameter	Symbol	Ratings	Unit	Notice
Supply Voltage	Vcc	2.7~5.5	V	—
Operating Temperature	Topr	-30~+65	°C	—
Storage Temperature	Tstg	-40~+85	°C	—
Soldering Temperature	Tsol	260	°C	4mm from mold body less than 5 sec

● **Electrical And Optical Characteristics**($T_a=25^{\circ}\text{C}$)

Parameter	Symbol	Condition	Ratings			Unit
			Min.	Typ.	Max.	
Supply Voltage	Vcc	DC voltage	2.7	—	5.5	V
Supply Current	Icc	No signal input	—	—	1.5	mA
Reception Distance	L	At the ray axis	12	—	—	m
		In the range of 45° cone	6	—	—	
B.P.F Center Frequency	f _o	—	—	38	—	KHz
Peak Wavelength	λ _p	—	—	940	—	nm
Half Angle	θ	—	—	45	—	deg
High Level Pulse Width	T _H	Specified by the output T _H period within a range from 10cm to the arrival distance (average value of 50 pulses)	400	—	800	μS
Low Level Pulse Width	T _L	Specified by the output T _L period within a range from 10cm to the arrival distance (average value of 50 pulses)	400	—	800	μS
High Level Output Voltage	V _H	10cm over the ray axis	4.5	—	—	V
Low Level Output Voltage	V _L	10cm over the ray axis	—	—	0.5	V

● Application Circuit

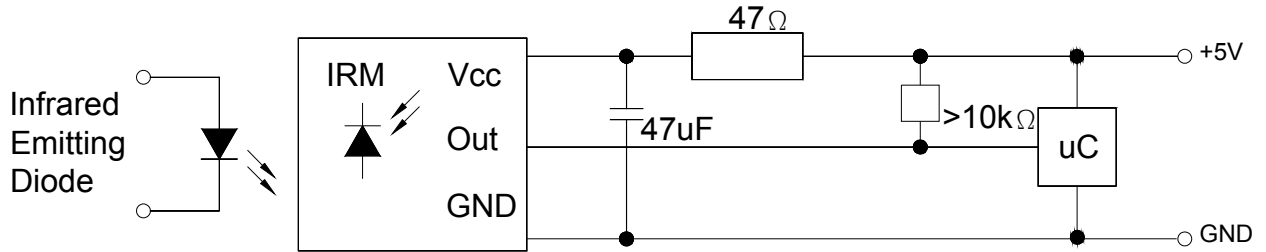

Fig.1 Transmitter Wave Form

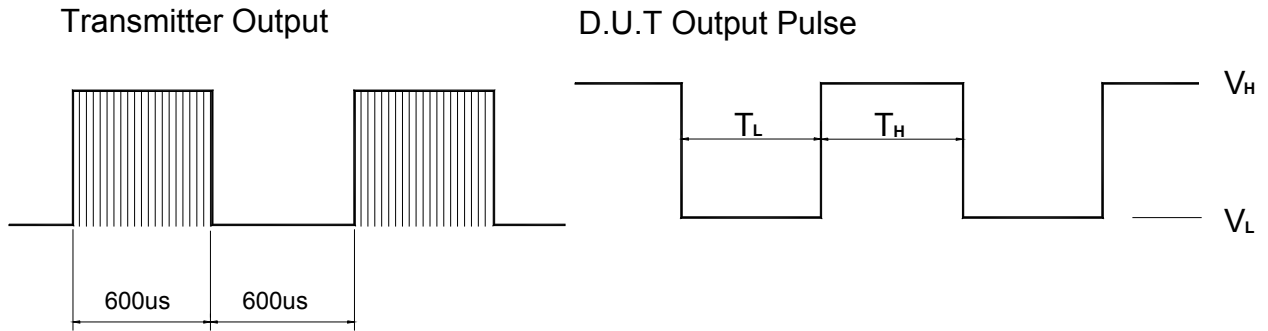

Fig.2 Measuring Method

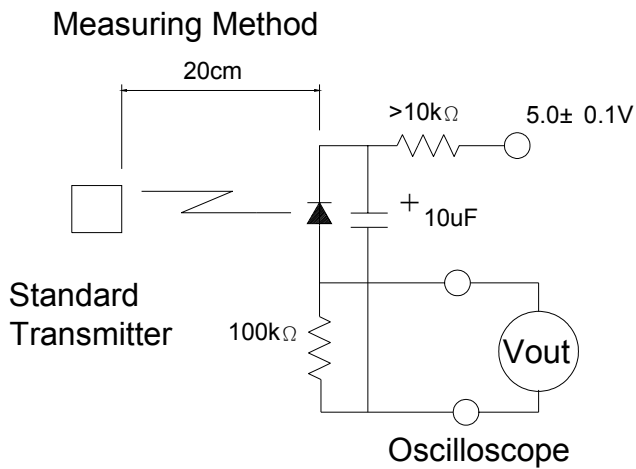
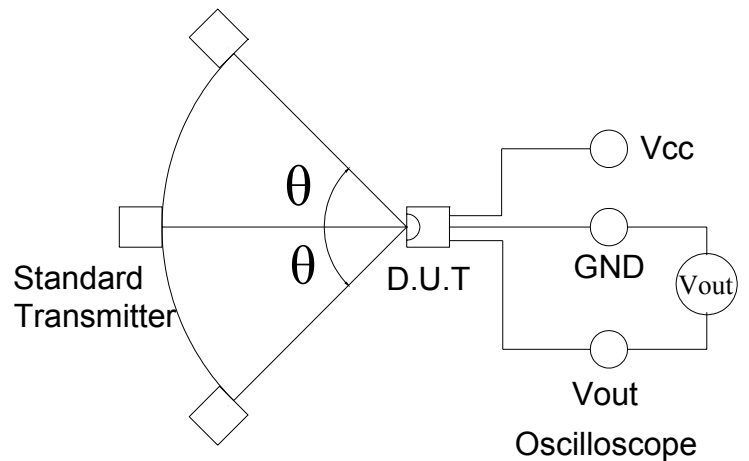

Fig.3 Measuring System



● **Electrical And Optical Curves(Ta=25°C)**

Fig.4 Relative Spectral Sensitivity vs. Wavelength

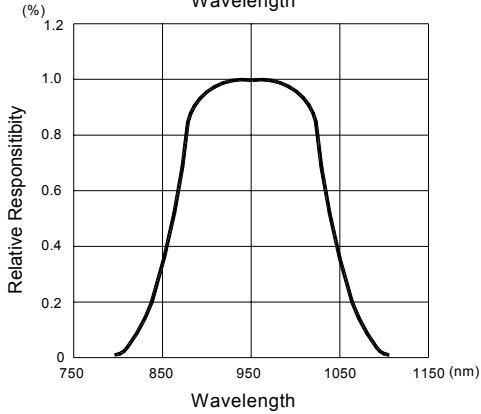

Fig.5 Relative Transmission Distance vs. Direction

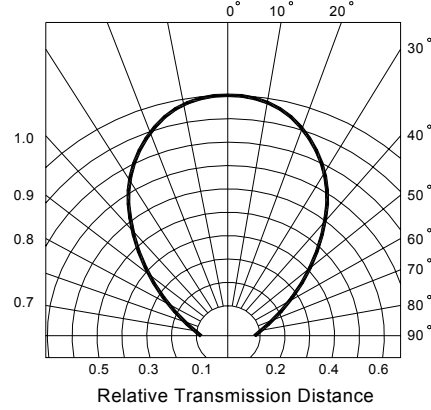

Fig.6 Output Pulse Diagram

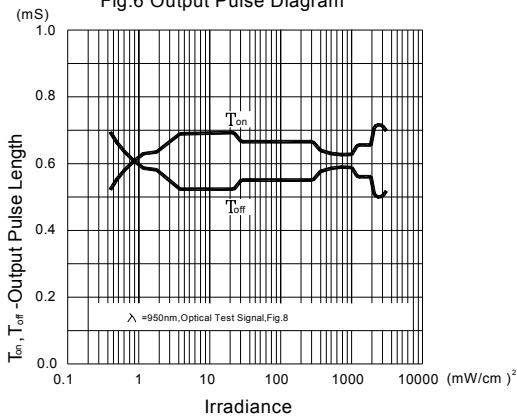

Fig.7 Supply Current vs. Ambient Temperature

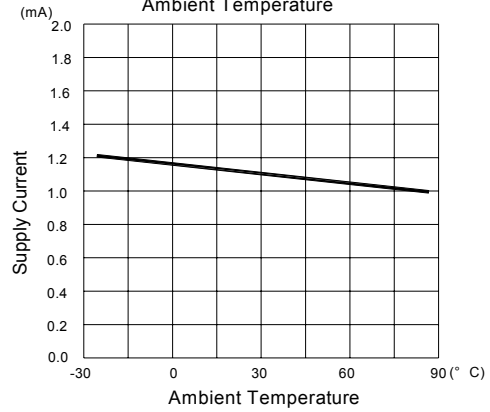

Fig.8 Frequency Dependence of Responsivity

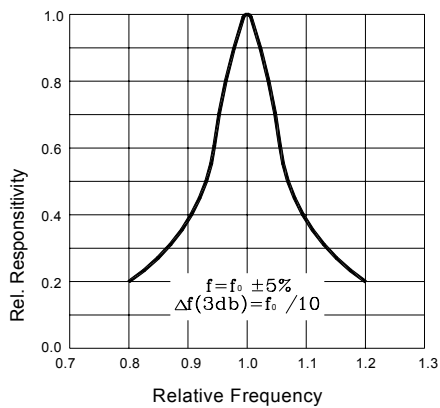
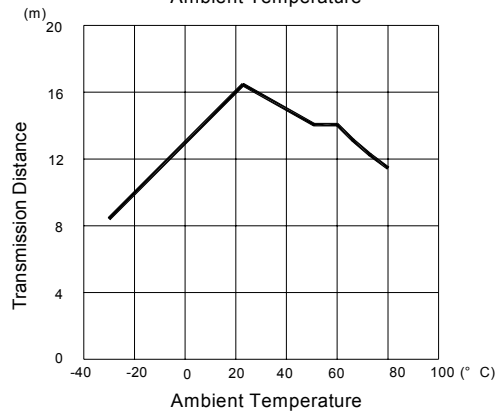
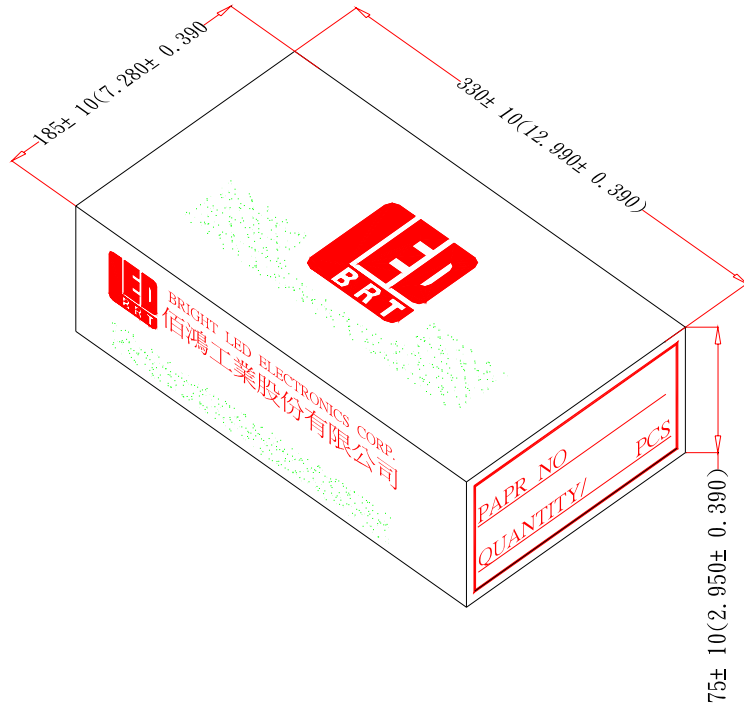

Fig.9 Arrival Distance Vs. Ambient Temperature



● Packaging Box Dimensions



● Packaging Bag Dimensions

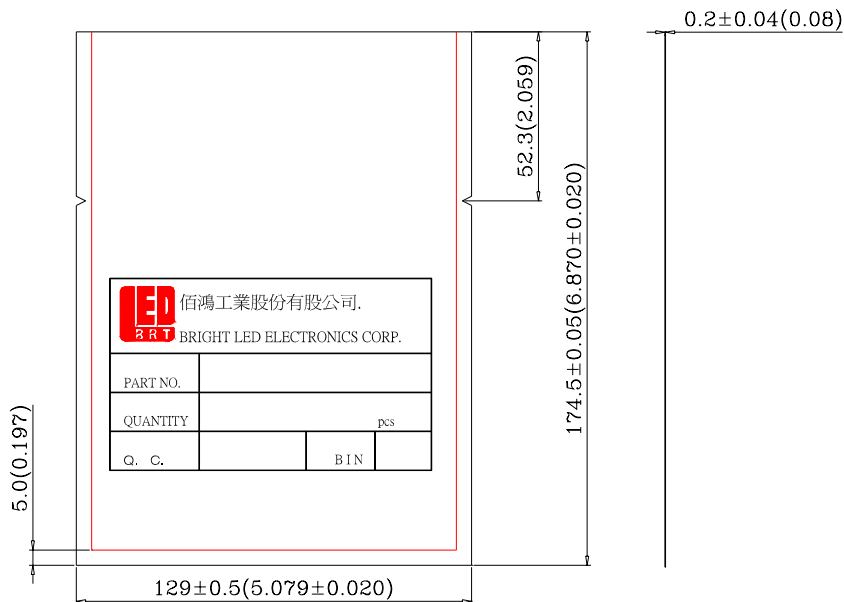

Notes:

- 1、250pcs per bag, 3Kpcs per box.
- 2、All dimensions are in millimeters(inches).
- 3、Specifications are subject to change without notice.