

Battery holder for coin-type Lithium Battery

BH820(For CR/LIR2032,2025,2016)

- *The battery is solidly anchored in the holder
- *Battery can be charged very easily and you are assured of reliable firm contact
- *There is no battery damage from short circuiting or soldering.
- *BH820 battery holder for CR and LIR series 2032 to 2025,2016.

CONTACT:
0.5mm PHOSPHOR BRONZE ALLOY W/TIN PLATED

CONTACT LOADING:
3 AMP

COLOUR:
BLACK

OPERATION TEMP:
-55°C+125°C

DURABILITY:
50 CYCLES PLUG-IN-OUT (SAME TYPE)

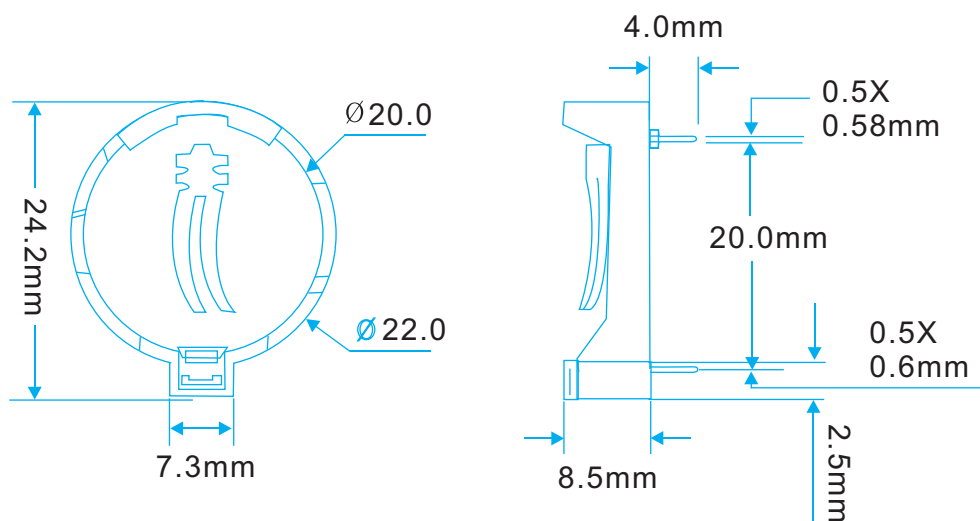

Specifications subject to change without notice