



High Power LED

Edixeon™ Star

3W Edixeon™

Approved By Customer	Designer	Checker	Approval

Date : 2006/03/02

Version : 1.3

Device No. : 3-RD-01-E0008
EDISON OPTO CORPORATION
 4F, No. 800, Chung-Cheng Rd,
 Chung-Ho, Taipei 235, Taiwan
 Tel: 886-2-8227-6996
 Fax: 886-2-8227-6997
<http://www.edison-opto.com.tw>



EdixeonTM



Edixeon star is an edixeon emitter on an Alumina PCB the highest flux LEDs in the world by Edison Opto. Edixeon emitters are designed to satisfy more and more Solid-State lighting High Power LED applications for brilliant world such as flash light, indoor and outdoor decoration light. Edixeon emitters are designed by particular package for High Power LED. 3W Edixeon white has more than 90 lumens @700mA. Unlike most fluorescent sources, Edixeon contains no mercury and has more energy efficient than other incandescent light source.

Features

- Various colors
- More energy efficient than incandescent and most halogen lamps
- Low voltage operated
- Instant light
- Long operating life

Typical Applications

- Reading lights
- Portable flashlight
- Up-lighters and Down-lighters
- LCD Backlights
- General lighting
- Contour lights
- Ceiling lights
- Garden lighting
- Decoration lights
- Architectural lighting
- Beacon lights



Package Outlines

Lambertian

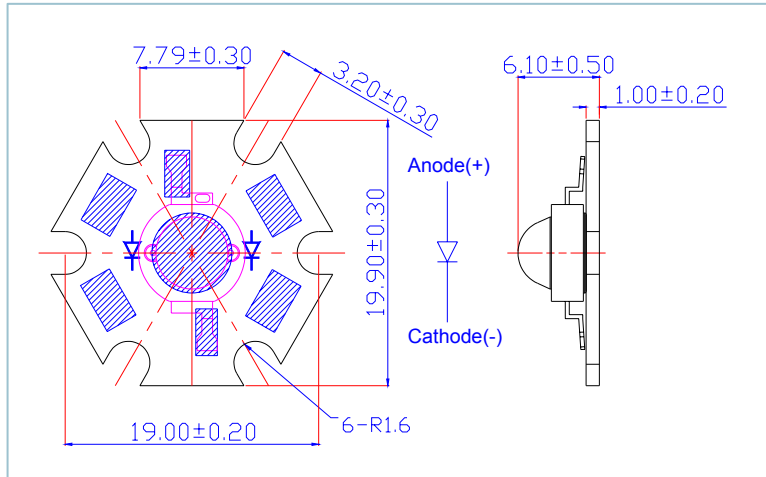

Notes:

1. All dimensions are in mm.
2. It is strongly recommended that the temperature of lead be not higher than 55°C

Absolute Maximum Ratings

Parameter	Symbol	Rating	Units
DC Forward Current	I_F	700	mA
Peak pulse current;(tp≤100μs, Duty cycle=0.25)	I_{pulse}	1000	mA
Reverse Voltage	V_R	5	V
Reverse Current($V_R=5V$)	I_R	50	μA
LED junction Temperature (at 350 mA)	T_j	125	°C
Operating Temperature	T_{opr}	-30 ~ +110	°C
Storage Temperature	T_{stg}	-40 ~ +120	°C
Manual Soldering Time at 260°C (Max.)	T_{sol}	5	seconds

Luminous Flux Characteristics at $I_F=700mA(T_a=25^{\circ}C, T_{opr}=100ms)$:

Lens Item	Part Name	Color	Flux			Units
			Min.	Typ.	Max.	
Lambertian	EDSW-3Lax	White	51.2	90	--	lm
	EDSX-3Lax	Warm White	39.4	60	--	lm
	EDSR-3Lax	Red	39.4	65	--	lm
	EDSO-3Lax	Red Orange	51.2	70	--	lm
	EDSA-3Lax	Amber	39.4	65	--	lm
	EDST-3Lax	True Green	51.2	90	--	lm
	EDSB-3Lax	Blue	13.8	30	--	lm

Luminous Flux Characteristics at $I_F=1000mA$ or $1400mA(T_a=25^{\circ}C, T_{opr}=100ms)$:

Lens Item	Part Name	Color	Flux(Typ.)		Units
			1000mA	1400mA	
Lambertian	EDSW-3Lax	White	120.0	--	lm
	EDSX-3Lax	Warm White	80.0	--	lm
	EDSR-3Lax	Red	--	110.0	lm
	EDSO-3Lax	Red Orange	--	120.0	lm
	EDSA-3Lax	Amber	--	100.0	lm
	EDST-3Lax	True Green	120.0	--	lm
	EDSB-3Lax	Blue	90.0	--	lm

Forward Voltage Characteristics at $I_F=700\text{mA}$ ($T_a=25^\circ\text{C}$, $T_{opr}=100\text{ms}$):

Lens Item	Part Name	Color	V_F			Units
			Min.	Typ.	Max.	
	EDSW-3Lax	White	3.1	--	4.3	V
	EDSX-3Lax	Warm White	3.1	--	4.3	V
	EDSR-3Lax	Red	2.0	--	3.0	V
Lambertian	EDSO-3Lax	Red Orange	2.0	--	3.0	V
	EDSA-3Lax	Amber	2.0	--	3.0	V
	EDST-3Lax	True Green	2.8	--	4.0	V
	EDSB-3Lax	Blue	3.1	--	4.3	V

Wavelength or Color Temperature Characteristics at $I_F=700\text{mA}$ ($T_a=25^\circ\text{C}$, $T_{opr}=100\text{ms}$):

Lens Item	Part Name	Color	λ_d/CCT			Units
			Min.	Typ.	Max.	
	EDSW-3Lax	White	5000	--	8000	K
	EDSX-3Lax	Warm White	2800	--	3800	K
	EDSR-3Lax	Red	620	--	630	nm
Lambertian	EDSO-3Lax	Red Orange	610	--	620	nm
	EDSA-3Lax	Amber	585	--	595	nm
	EDST-3Lax	True Green	515	--	535	nm
	EDSB-3Lax	Blue	460	--	475	nm

Temperature Coefficient of Forward Voltage & Thermal Resistance Junction to Board Characteristics at $I_F=700\text{mA}$ ($T_a=25^\circ\text{C}$):

Lens Item	Part Name	Color	$\Delta V_F/\Delta T$		$R\theta_{J-B}$	
			Typ.	Units	Typ.	Units
	EDSW-3Lax	White	-2	<i>mV/°C</i>	12	<i>°C/W</i>
	EDSX-3Lax	Warm White	-2	<i>mV/°C</i>	12	<i>°C/W</i>
	EDSR-3Lax	Red	-2	<i>mV/°C</i>	12	<i>°C/W</i>
Lambertian	EDSO-3Lax	Red Orange	-2	<i>mV/°C</i>	12	<i>°C/W</i>
	EDSA-3Lax	Amber	-2	<i>mV/°C</i>	12	<i>°C/W</i>
	EDST-3Lax	True Green	-2	<i>mV/°C</i>	12	<i>°C/W</i>
	EDSB-3Lax	Blue	-2	<i>mV/°C</i>	12	<i>°C/W</i>

Emission Angle Characteristics at $I_F=700\text{mA}$ ($T_a=25^\circ\text{C}$):

Part Name	Color	$2\theta^{1/2}$			Units
		Max.	Typ.	Min.	
EDSW-3Lax	White	--	130	--	Degrees
EDSX-3Lax	Warm White	--	130	--	Degrees
EDSR-3Lax	Red	--	120	--	Degrees
EDSO-3Lax	Red Orange	--	120	--	Degrees
EDSA-3Lax	Amber	--	120	--	Degrees
EDST-3Lax	True Green	--	150	--	Degrees
EDSB-3Lax	Blue	--	150	--	Degrees

Note

1. Flux is measured with an accuracy of $\pm 10\%$.
2. CCT selection acc. to CCT groups and an accuracy of $\pm 200\text{K}$
3. Forward Voltage is measured with an accuracy of $\pm 0.1\text{V}$
4. Wavelength is measured with an accuracy of $\pm 0.5\text{nm}$
5. All white, warm white and blue emitters are built with InGaN
6. All red, red-orange and amber emitters are built with AlGaInP

Electrical & Optical Curves-Spectrum

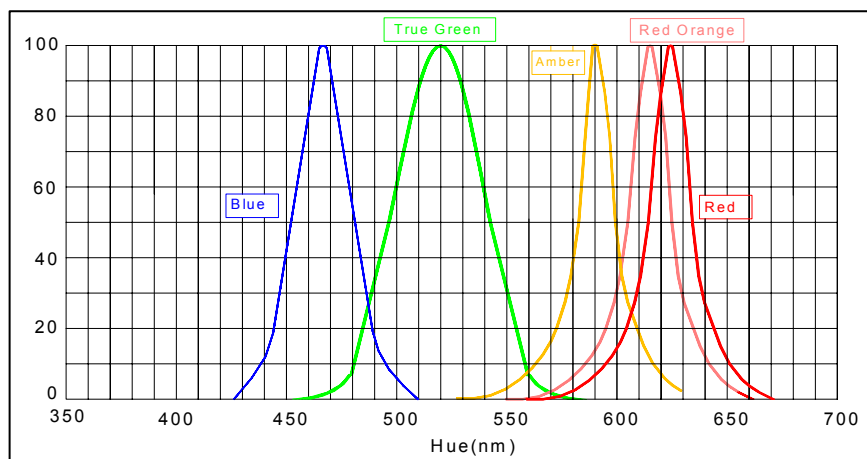
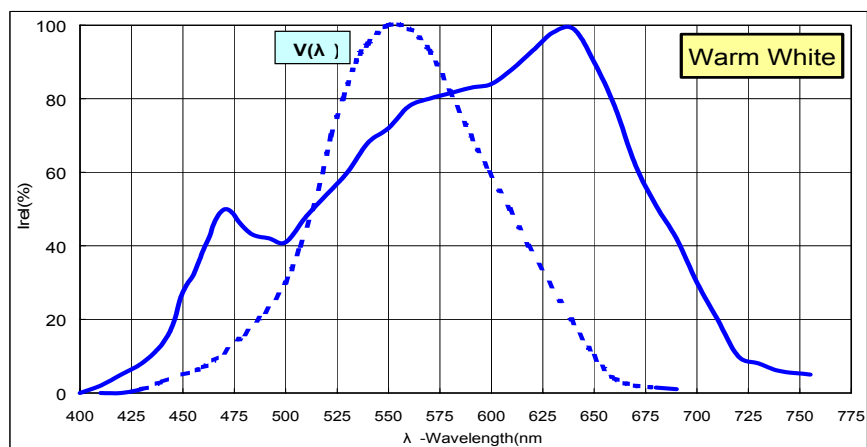
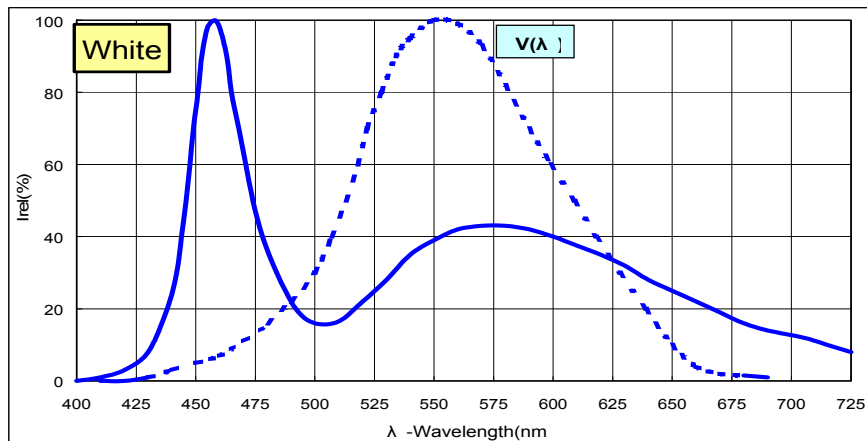

Typical Radiation Pattern for

Lambertian

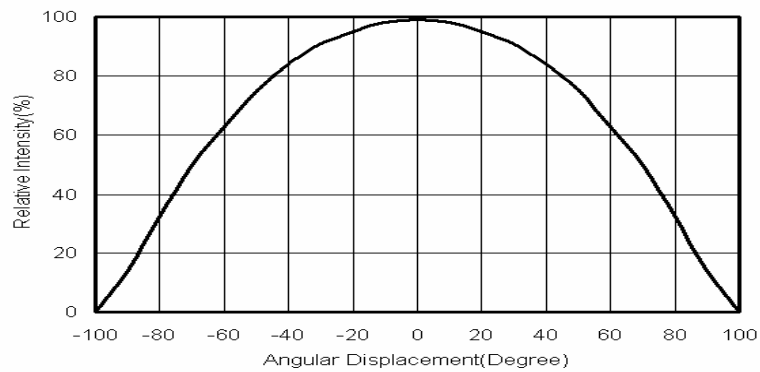

Typical Optical and Electrical Curves

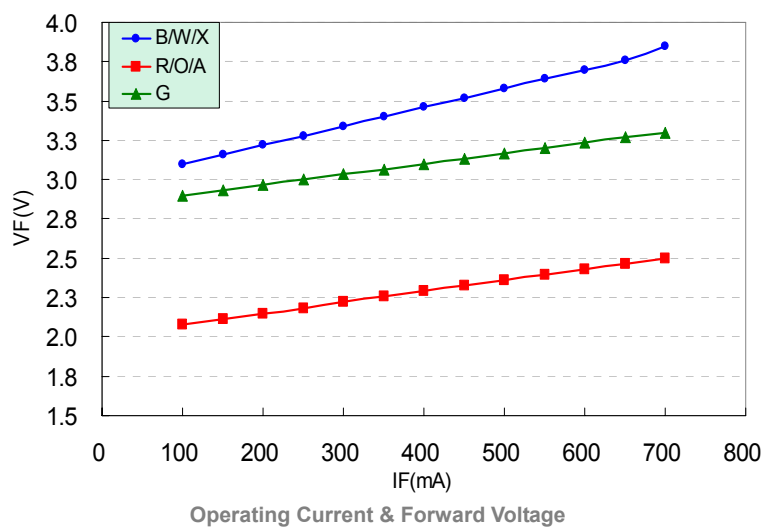
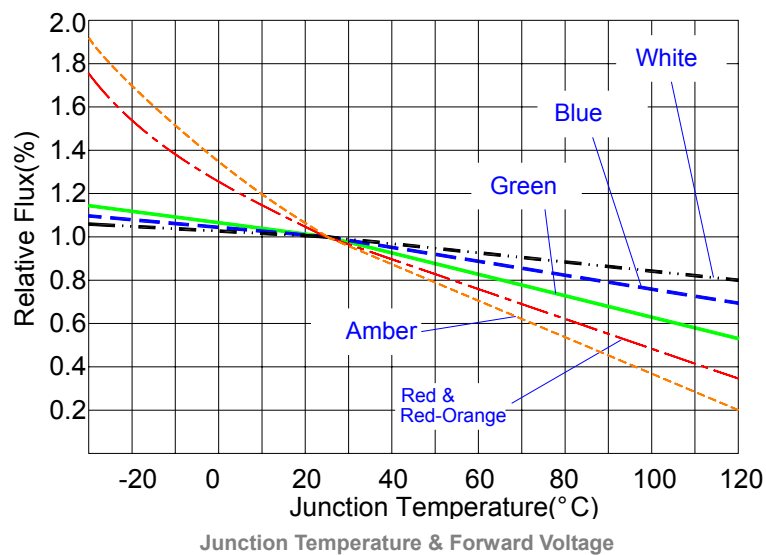

Typical Optical and Electrical Curves

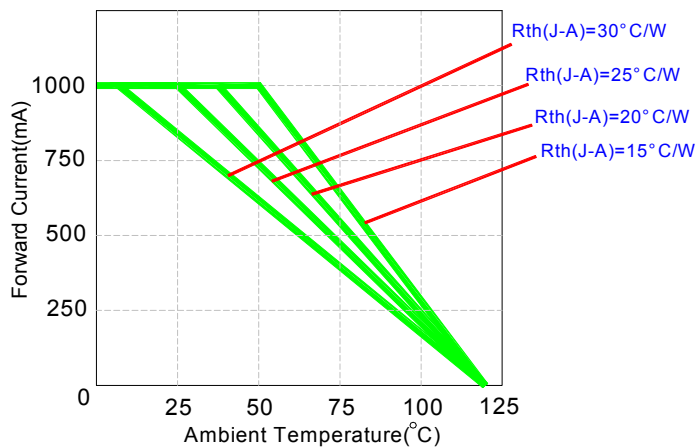

Operating Current & Ambient Temperature

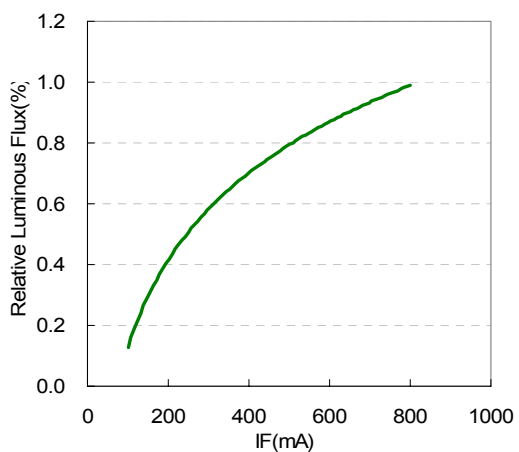

Forward Current & Luminous Flux

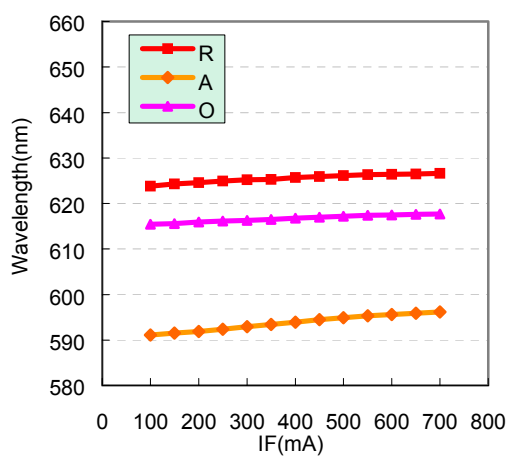
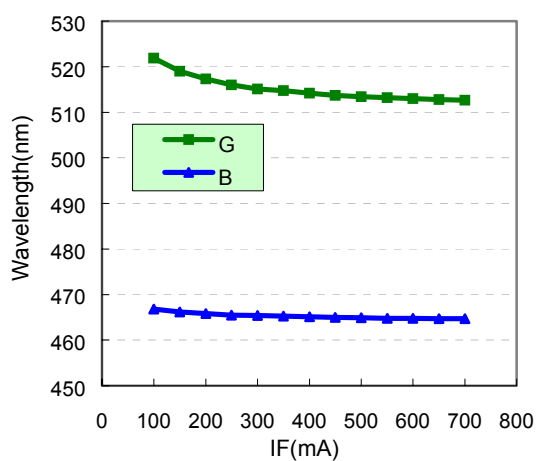

Forward Current & Wavelength

Package Specifications

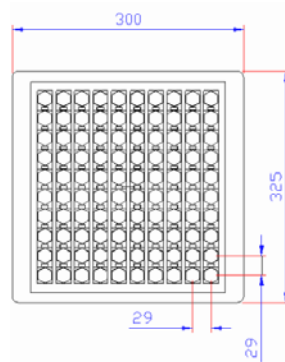
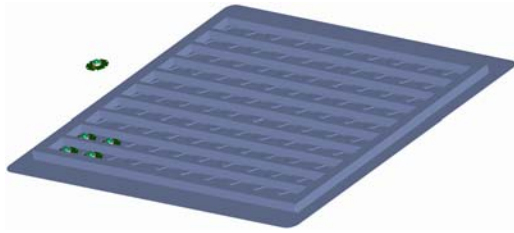

Figure 1: Tray

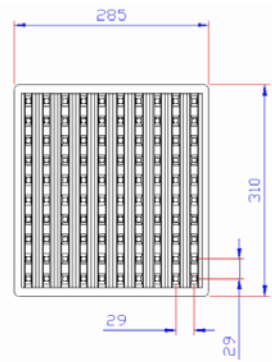

Figure 2: Cover

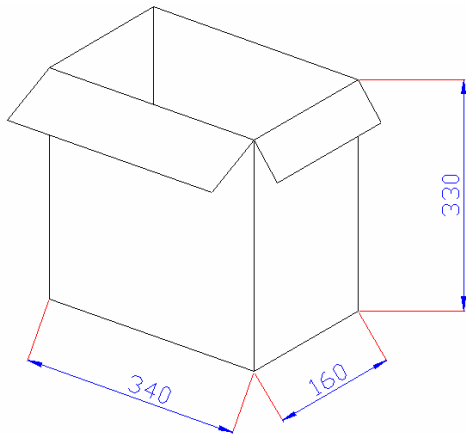

Figure 3: Inner box

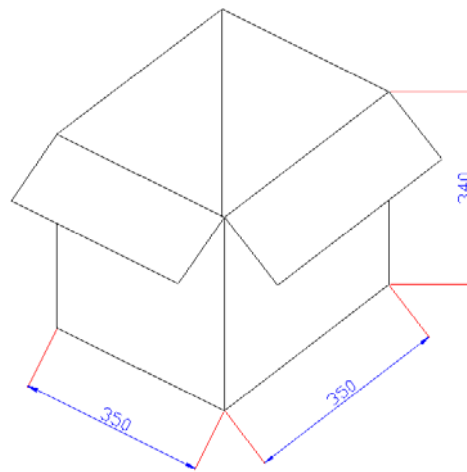

Figure 4: Outer box

Note

1. All dimensions are in mm.
2. There are 100pcs stars in a tray.(Tray+Cover)
3. There are 10 trays in an inner box.
4. There are 2 inner boxes in an outer box.