

# Edixeon<sup>®</sup> Federal Series

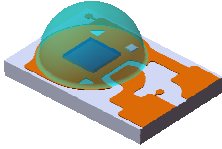

Edixeon<sup>®</sup> Federal is a surface mount, compact, high brightness LED that is built for various illumination needs. A single Cool White Edixeon<sup>®</sup> Federal can deliver typical luminous flux of 80 lm while driving at 350mA suitable for any kind of lighting sources, including general illumination, flashlights, streetlights, spotlights, signal lights, industrial and commercial lightings. The small physical dimension can free customers from any constraints or limitations in these fields of applications. Furthermore, the reflow-solderable nature of Edixeon<sup>®</sup> Federal provides an easy path towards the optimum thermal management to achieve a promising reliability. In conclusion, Edixeon<sup>®</sup> Federal offers you an extraordinary LED experience.

## Features

- High lumen performance
- Promising lumen maintenance characteristics
- High efficiency package
- Level 1 on JEDEC moisture sensitivity analysis
- 350mA – 700mA drive current
- RoHS compliant

## Typical Applications

- Reading lights
- Up-lights and Down-lights
- General lighting
- Ceiling lights
- Decoration lights
- Beacon lights
- Portable flashlight
- LCD Backlights
- Contour lights
- Garden lighting
- Architectural lighting

## Table of Contents

<b>Edixeon® Federal Nomenclature</b> -----	<b>3</b>
<b>Environmental Compliance</b> -----	<b>3</b>
<b>E-Type Package Dimensions</b> -----	<b>4</b>
<b>E-Type Package Polarity</b> -----	<b>5</b>
<b>Absolute Maximum Rating</b> -----	<b>6</b>
<b>Luminous Flux Characteristics</b> -----	<b>7</b>
<b>Forward Voltage Characteristics</b> -----	<b>9</b>
<b>JEDEC Moisture Sensitivity</b> -----	<b>10</b>
<b>Edixeon® Federal Reliability Items and Failure Criteria</b> -----	<b>11</b>
<b>Color Spectrum &amp; Radiation Pattern</b> -----	<b>12</b>
<b>Optical and Electrical Curves</b> -----	<b>13</b>
<b>Edixeon® Federal Reflow Soldering Instructions</b> -----	<b>20</b>
<b>Product Packaging</b> -----	<b>21</b>
<b>Edixeon® Federal Bin Groups</b> -----	<b>23</b>

**Edixeon® Federal Nomenclature:**

**E F E W - 1 A E 1**  
 X1 X2 X3 X4 X5 X6 X7

**Table 1.**

X1		X2		X3			X4		X5	
LED Item		Module		Emitting Color			Power		Substrate Type	
Code	Type	Code	Type	Code	Type		Code	Type	Code	Type
EF	Edixeon Federal	E	Emitter	W	White	○	1	350mA	A	4.5mm x 3mm
		S	Star	H	Neutral White	●	3	700mA		
				X	Warm White	●				
				R	Red	●				
				A	Amber	●				
				T	Green	●				
				B	Blue	●				
				D	Dental Blue	●				
				C	Royal Blue	●				
				J	Cyan	●				
				E	Deep Red	●				
				F	Cherry Red	●				
				V	Ultraviolet	●				

X6		X7	
Emitter Type		Internal Usage	
Code	Type	Code	Type
E	E-type	1	

**Environmental Compliance:**

Edixeon® Federal is compliant to the Restriction of Hazardous Substances Directive or RoHS. The restricted materials including lead, mercury cadmium hexavalent chromium, polybrominated biphenyls (PBB) and polybrominated diphenyl ether (PBDE) are not used in Edixeon® Federal to provide an environmentally friendly product to the customers.

## E-Type Package Dimensions:

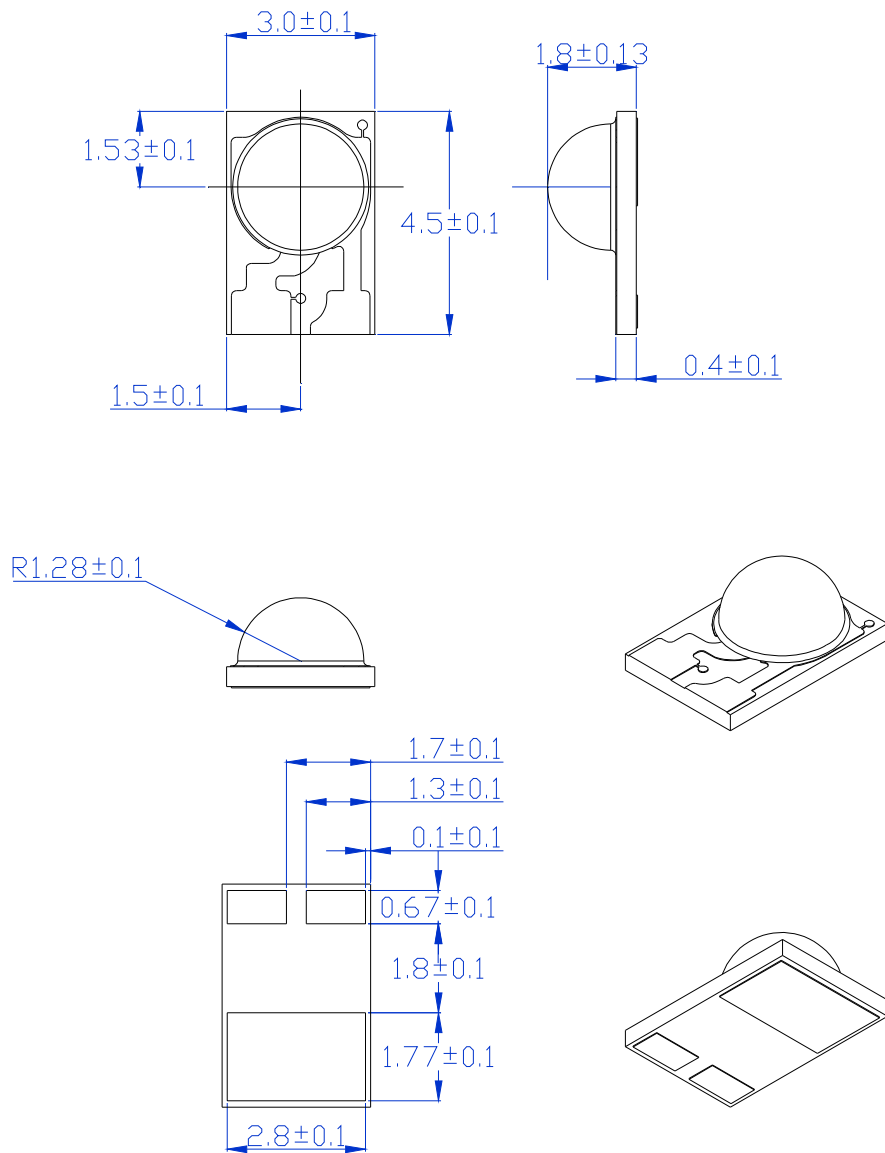
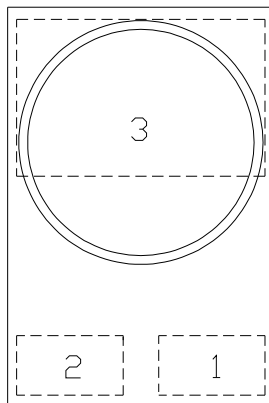

Figure 1: E-Type Package Drawings

**Notes:**

1. All dimensions are in millimeters.
2. Drawings are not to scale.

**E-Type Package Polarity:**



**TOP**

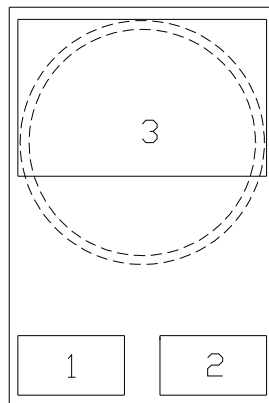

**BOTTOM**

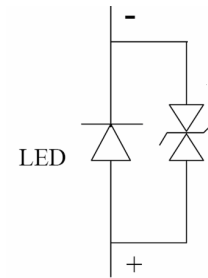

PAD	FUNCTION
1	ANODE
2	CATHODE
3	THERMAL

Figure 2: E-Type Pad Configuration

**Note:**

The thermal pad is electrically isolated from anode and cathode.

## Absolute Maximum Ratings:

Table 2.

Parameter	Symbol	Rating	Units
DC Forward Current <sup>[1]</sup>	I <sub>F</sub>	350 / 700	mA
Peak Pulsed Current; (t <sub>p</sub> ≤ 100μs, Duty cycle=0.25)	I <sub>pulse</sub>	1000	mA
Transient Surge Voltage	V <sub>TS</sub>	8	V
Reverse Voltage <sup>[2]</sup>	V <sub>r</sub>	Note 2	V
LED Junction Temperature <sup>[3]</sup>	T <sub>j</sub>	150 / 125 <sup>[4]</sup>	°C
Operating Temperature	T <sub>opr</sub>	-40 ~ +80	°C
Storage Temperature	T <sub>stg</sub>	-40 ~ +120	°C
ESD Sensitivity	V <sub>B</sub>	2,000	V
Allowable Reflow Cycles	n/a	3	cycles
Soldering Temperature	T <sub>sol</sub>	260	°C

### Notes:

1. Maximum forward current for 1W and 3W are 350mA and 700mA respectively.
2. LEDs are not designed to drive in reverse bias.
3. Proper current derating must be observed to maintain junction temperature below the maximum.
4. The maximum junction temperature for Red, Amber, Deep Red and Cherry Red is 125°C.

### Luminous Flux Characteristics, $I_F=350\text{mA}$ and Thermal Pad= $25^\circ\text{C}$ :

Table 3.

Power Consumption	Part Name	Color	Flux			Units
			Min.	Typ.	Max.	
1W	EFEW-1AE1	Cool White	--	<b>80</b>	--	lm
	EFEH-1AE1	Neutral White	--	<b>65</b>	--	lm
	EFEY-1AE1	Warm White	--	<b>55</b>	--	lm
	EFER-1AE1	Red	--	<b>40</b>	--	lm
	EFEA-1AE1	Amber	--	<b>40</b>	--	lm
	EFET-1AE1	True Green	--	<b>70</b>	--	lm
	EFEB-1AE1	Blue	--	<b>18</b>	--	lm
	EFED-1AE1	Dental Blue	--	<b>300</b>	--	mW
	EFEC-1AE1	Royal Blue	--	<b>320</b>	--	mW
	EFEJ-1AE1	Cyan	--	<b>30</b>	--	lm
	EFEI-1AE1	Deep Red	--	<b>135</b>	--	mW
	EFEF-1AE1	Cherry Red	--	<b>110</b>	--	mW
	EFEV-1AE1	Ultraviolet	--	<b>210</b>	--	mW

### Luminous Flux Characteristics, $I_F=700\text{mA}$ and Thermal Pad= $25^\circ\text{C}$ :

Table 4.

Lens Item	Part Name	Color	Flux			Units
			Min.	Typ.	Max.	
3W	EFEW-3AE1	Cool White	--	<b>136</b>	--	lm
	EFEH-3AE1	Neutral White	--	<b>110</b>	--	lm
	EFEY-3AE1	Warm White	--	<b>100</b>	--	lm
	EFER-3AE1	Red	--	<b>70</b>	--	lm
	EFET-3AE1	True Green	--	<b>110</b>	--	lm
	EFEB-3AE1	Blue	--	<b>27</b>	--	lm

**Note:**

The luminous flux performance is guaranteed within published operating conditions. Edison maintains a tolerance of  $\pm 10\%$  on flux measurements.

**Color Temperature or Dominant/Peak Wavelength Characteristics,  $T_J=25^\circ\text{C}$  at 350mA :**

Table 5.

Power Consumption	Part Name	Color	CCT/Wavelength			Units
			Min.	Typ.	Max.	
1W	EFEW-1AE1	Cool White	5,000	--	10,000	K
	EFEH-1AE1	Neutral White	3,800	--	50,00	K
	EFEY-1AE1	Warm White	2,670	--	3,800	K
	EFER-1AE1	Red	620	--	630	nm
	EFEA-1AE1	Amber	585	--	595	nm
	EFEF-1AE1	True Green	515	--	535	nm
	EFEB-1AE1	Blue	455	--	475	nm
	EFEJ-1AE1	Blue	450	--	470	nm
	EFEK-1AE1	Royal Blue <sup>[1]</sup>	440	--	460	nm
	EFEI-1AE1	Cyan	490	--	510	nm
	EFEH-1AE1	Deep Red <sup>[1]</sup>	650	--	670	nm
	EFEF-1AE1	Cherry Red <sup>[1]</sup>	730	--	750	nm
	EFEV-1AE1	Ultraviolet <sup>[1]</sup>	395	--	410	nm

**Notes:**

1. Wavelengths are stated as peak wavelength.
2. Edison maintains a tolerance of  $\pm 0.5\text{nm}$  for dominant wavelength,  $\pm 2\text{nm}$  for peak wavelength and  $\pm 5\%$  on CCT measurement.



## Forward Voltage Characteristics, $T_J=25^{\circ}\text{C}$ :

Table 6.

Power Consumption	Part Name	Color	Forward Current (mA)	$V_F$			Units
				Min.	Typ.	Max.	
1W	EFEW-1AE1	White	350	3.0	--	4.0	V
	EFEH-1AE1	Neutral White	350	3.0	--	4.0	
	EFEY-1AE1	Warm White	350	3.0	--	4.0	
	EFER-1AE1	Red	350	2.0	--	3.0	
	EFEA-1AE1	Amber	350	2.0	--	3.0	
	EFET-1AE1	True Green	350	2.8	--	4.0	
	EFEV-1AE1	Blue	350	3.0	--	4.0	
	EFED-1AE1	Dental Blue	350	3.0	--	4.0	
	EFEJ-1AE1	Royal Blue	350	3.0	--	4.0	
	EFEK-1AE1	Cyan	350	2.8	--	4.0	
	EFEF-1AE1	Deep Red	350	2.0	--	3.0	
	EFEH-1AE1	Cherry Red	350	2.0	--	3.0	
	EFEV-1AE1	Ultraviolet	350	3.0	--	4.0	
	3W	EFEW-3AE1	White	700	3.0	--	
EFEH-3AE1		Neutral White	700	3.0	--	4.0	
EFEY-3AE1		Warm White	700	3.0	--	4.0	
EFER-3AE1		Red	700	2.0	--	3.0	
EFET-3AE1		True Green	700	2.8	--	4.0	
EFEV-3AE1		Blue	700	3.0	--	4.0	

**Note:**

Edison maintains a tolerance of 0.06V on forward voltage measurement.

### Emission Angle Characteristics:

Table 7.

$2\Theta^{1/2}$ (Typ.) Lambertian	Units
120	Degrees

### JEDEC Moisture Sensitivity:

Table 8.

Level	Floor Life		Soak Requirements	
	Time	Conditions	Time (hours)	Standard Conditions
1	unlimited	$\leq 30^{\circ}\text{C} / 85\%$ RH	168 +5/-0	85 °C / 85% RH

### Thermal Resistance – Junction to Thermal Pad:

Table 9.

Thermal Resistance from Junction to Thermal Pad	Units
10	$^{\circ}\text{C} / \text{W}$

## Operating Life, Mechanical and Environmental Tests on Edixeon® Federal:

Table 10.

Stress Test	Stress Conditions	Stress Duration	Failure Criteria
Room Temperature Operating Life	55 °C, I <sub>F</sub> =DC max <sup>[1]</sup>	1000 hours	Note 2
High Temperature High Humidity Operating Life	85 °C / 85%RH, I <sub>F</sub> =DC max <sup>[1]</sup>	1000 hours	Note 2
High Temperature Operating Life	85 °C, I <sub>F</sub> =DC max <sup>[1]</sup>	1000 hours	Note 2
Low Temperature Operating Life	-40 °C, I <sub>F</sub> =DC max <sup>[1]</sup>	1000 hours	Note 2
High Temperature Storage Life	150 °C	1000 hours	Note 2
Low Temperature Storage Life	-40 °C	1000 hours	Note 2
Non-Operating Thermal Shock	-40 / 125°C, 20 min dwell < 10 sec transfer	500 cycles	No catastrophic
Mechanical Shock	1500 G, 0.5 msec pulse, 5 shocks each 6 axis	N/A	No catastrophic
Free Drop	On concrete from 1.2 m, 3X	N/A	No catastrophic
Variable Vibration Frequency	10-2000-10 Hz, log or linear sweep rate, 20 G about 1 min, 1.5 mm, 3X/axis	N/A	No catastrophic
Solder Heat Resistance (SHR)	Three JEDEC Pb-free reflow profile	N/A	No catastrophic

**Note:**

1. DC max is defined to be 350mA and 700mA for 1W and 3W Edixeon® Federal respectively.

2. Failure Criteria:

- Electrical failures: V<sub>F</sub> shifts >= 10%
- Light Output Degradation: Percentage level shift >= 50% at 1,000hrs or 500cycle
- Visual failures: Broken or damaged package on lens or substrate

**White Edixeon® Federal Color Spectrum,  $T_j = 25^\circ\text{C}$ :**

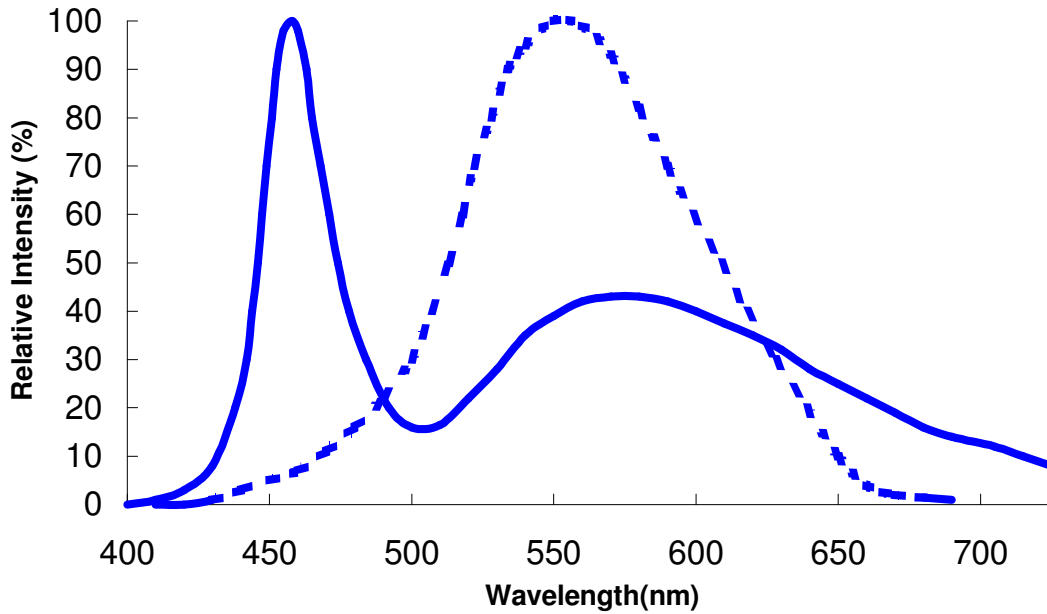

Figure 3: Color Spectrum for Cool White at a typical CCT. Dotted curve represents the standard eye response,  $T_j=25^\circ\text{C}$ .

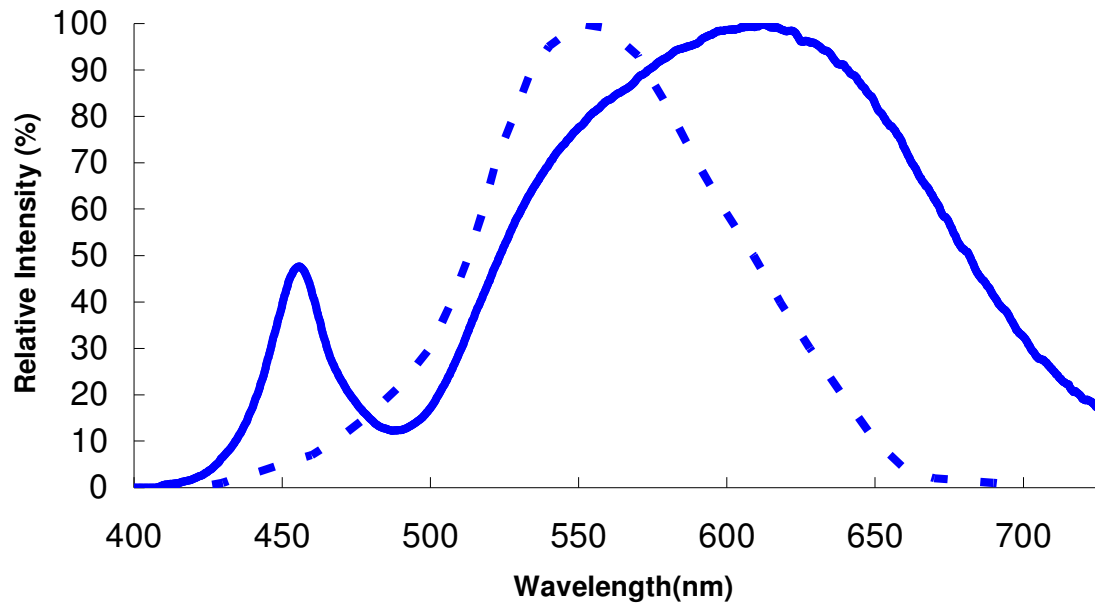

Figure 4: Color Spectrum for Neutral White and Warm White at a typical CCT. Dotted curve represents the standard eye response,  $T_j=25^\circ\text{C}$ .

**Typical Radiation Pattern,  $T_j = 25^\circ\text{C}$ :**

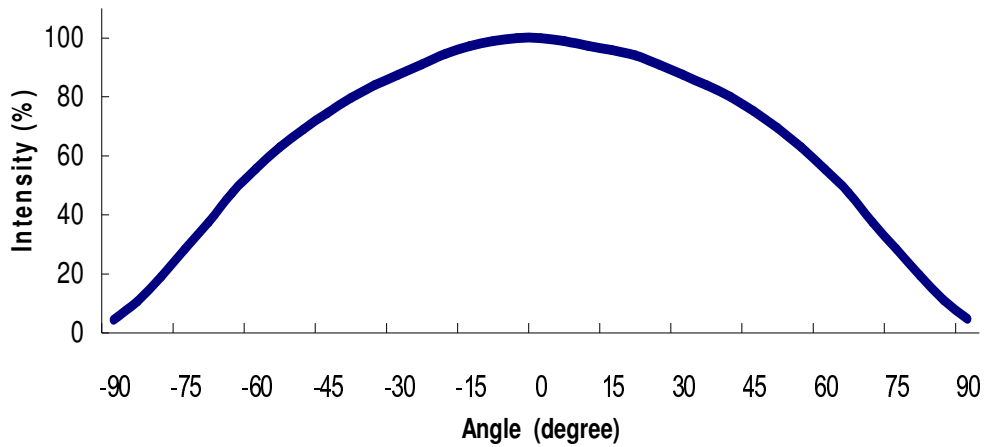

Figure 5: Lambertian Pattern for all colors at  $T_j=25^\circ\text{C}$ ..

**Optical & Electric Curves:**

**Current Derating Curve for 700mA Drive Current,  $T_j = 150^\circ\text{C}$**

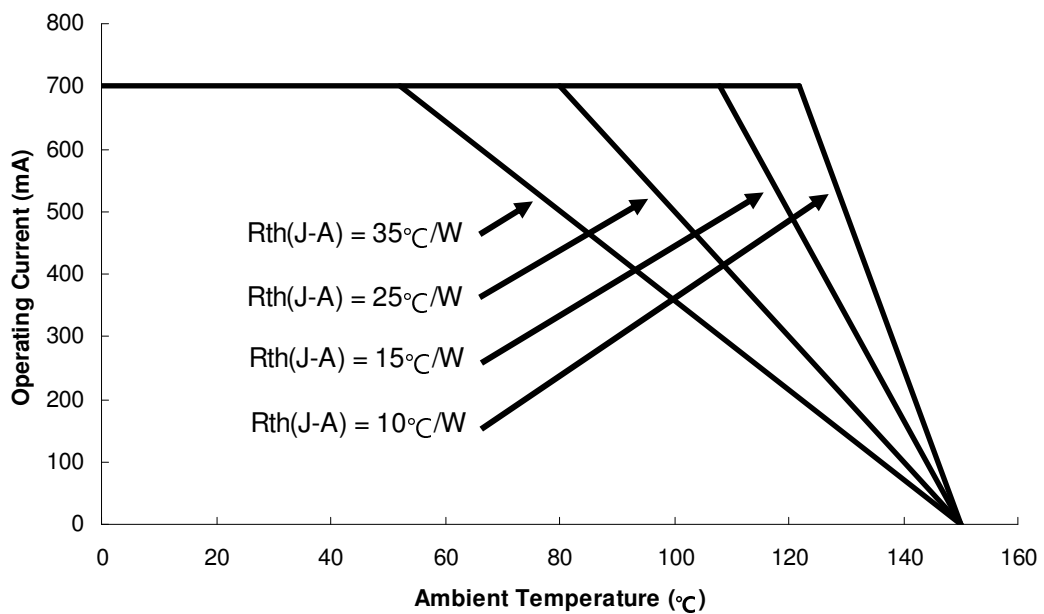

Figure 6: Maximum Operating Current vs Ambient Temperature for White, Blue, Green, Cyan, Royal Blue, Dental Blue and Ultraviolet.

**Current Derating Curve for 700mA Drive Current,  $T_j = 125^\circ\text{C}$**

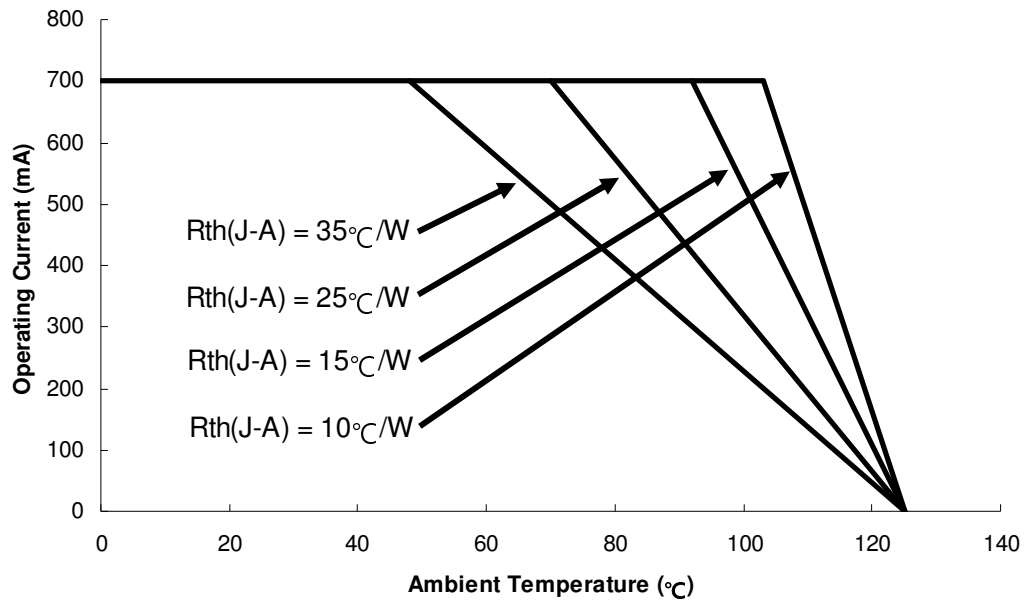

Figure 7: Maximum Operating Current vs Ambient Temperature for Red, Amber, Deep Red, Cherry Red.

**Typical Forward Voltage Characteristics for White, Blue, Dental Blue and Royal Blue Edixeon<sup>®</sup> Federal,  $T_j = 25^\circ\text{C}$**

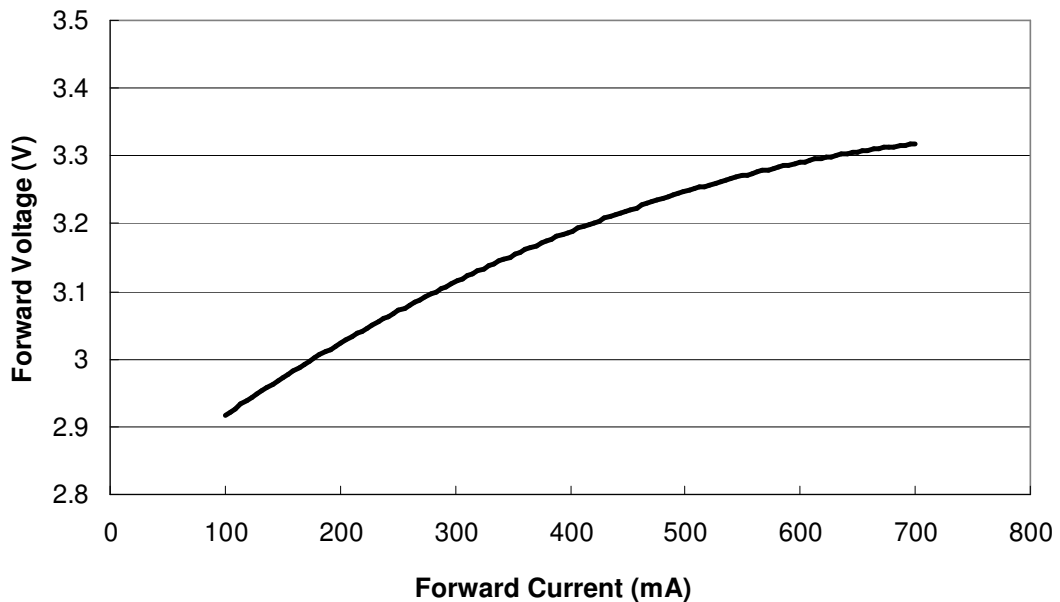

Figure 8: Forward voltage vs. forward current for White, Blue, Dental Blue and Royal Blue.

**Typical Forward Voltage Characteristics for  
True Green and Cyan,  $T_j = 25^\circ\text{C}$**

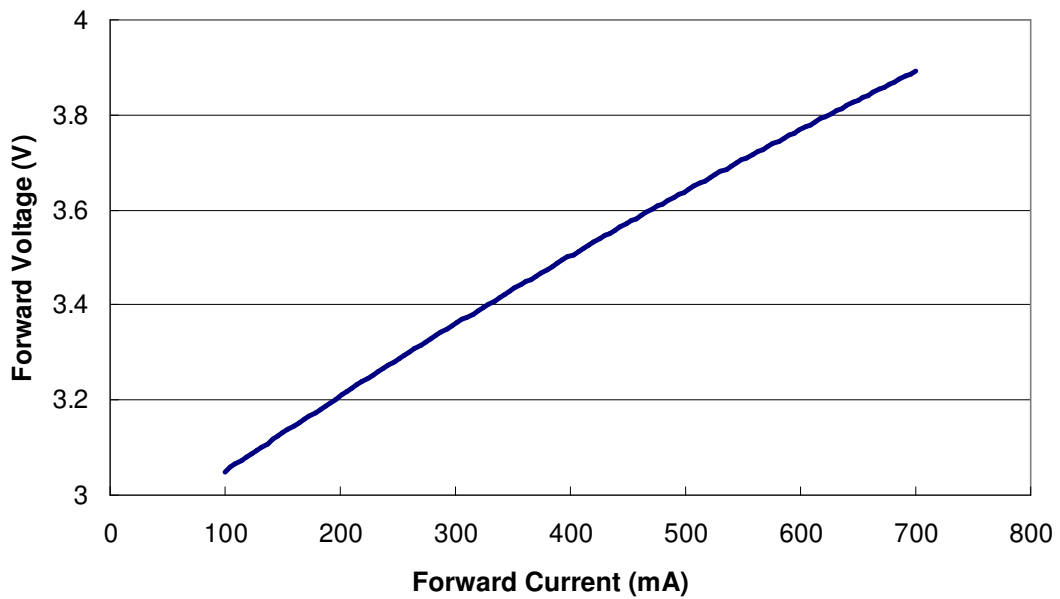

Figure 9: Forward voltage vs. forward current for True Green and Cyan.

**Typical Forward Voltage Characteristics for  
Red and Amber,  $T_j = 25^\circ\text{C}$**

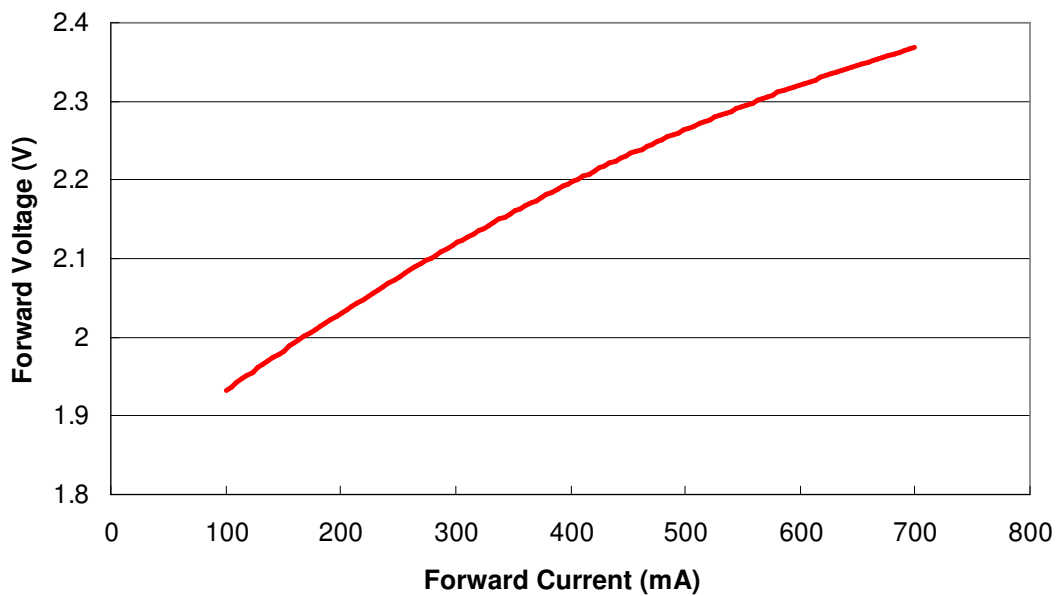

Figure 10: Forward voltage vs. forward current for Red and Amber.

**Typical Relative Luminous Flux for Cool White, True Green, Blue, Cyan, Dental Blue, and Royal Blue,  $T_j = 25^\circ\text{C}$**

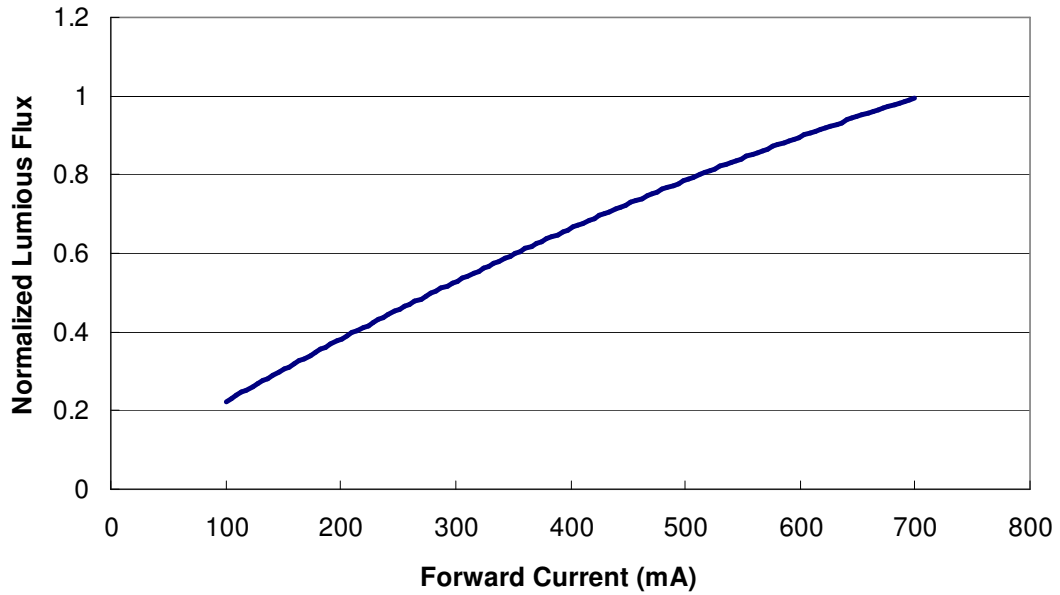

Figure 11: Relative luminous flux vs. forward current for Cool White, True Green, Blue, Cyan, Dental Blue and Royal Blue.

**Typical Relative Luminous Flux for Red and Amber,  $T_j = 25^\circ\text{C}$**

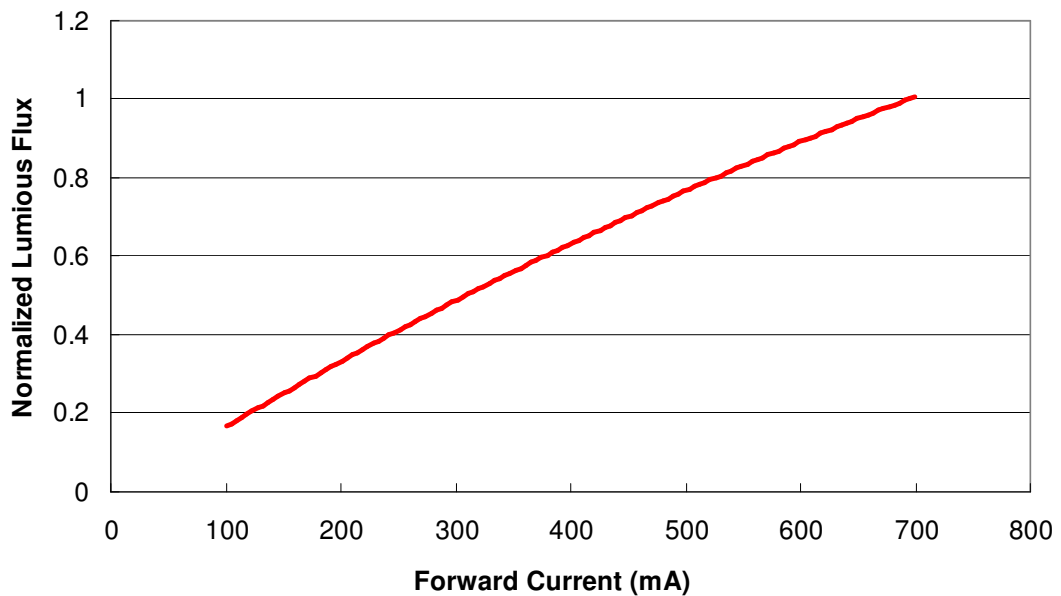

Figure 12: Relative luminous flux vs. forward current for Red and Amber.



**Typical Wavelength Shift Characteristic for True Green and Blue,  $T_j = 25^\circ\text{C}$**

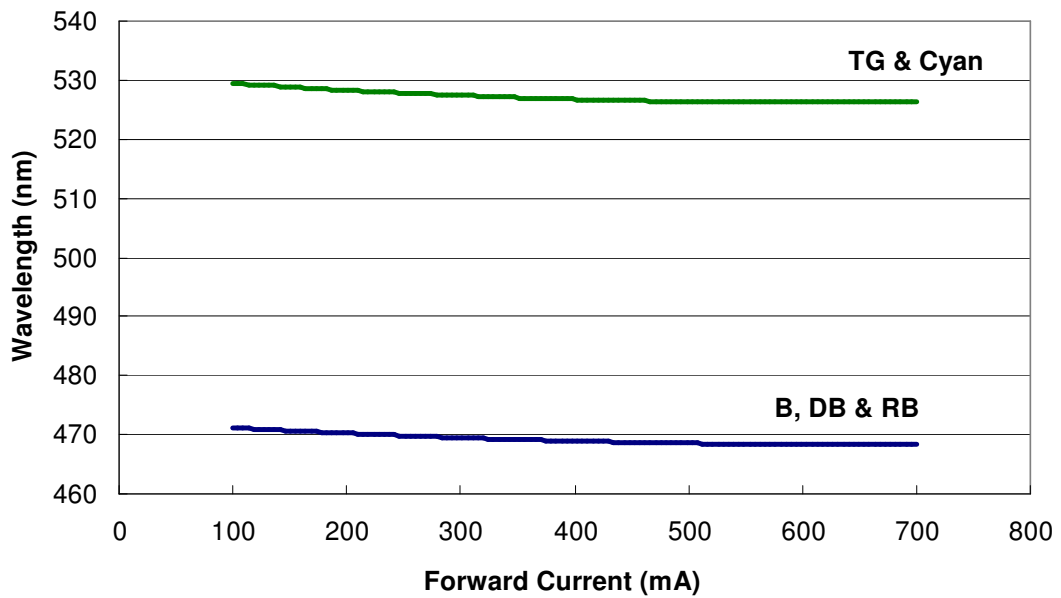

Figure 13: Wavelength length vs. forward current for True Green, Blue, Cyan, Royal Blue and Dental Blue.

**Typical Wavelength Shift Characteristic for Red and Amber,  $T_j = 25^\circ\text{C}$**

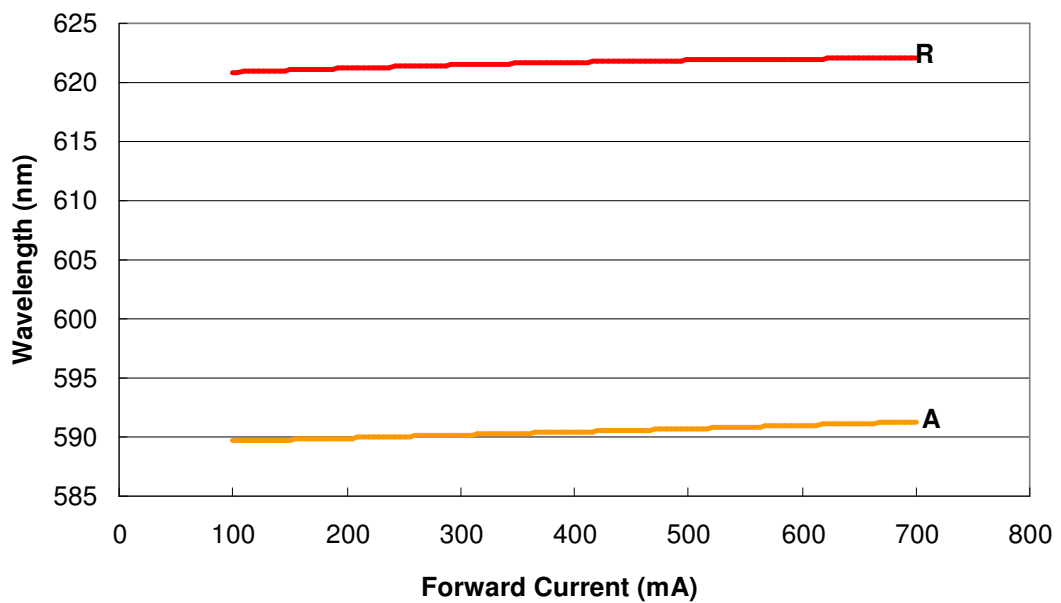

Figure 14: Wavelength length vs. forward current for Red and Amber.

**Typical CCT Shift Characteristic for Cool White  $T_j = 25^\circ\text{C}$**

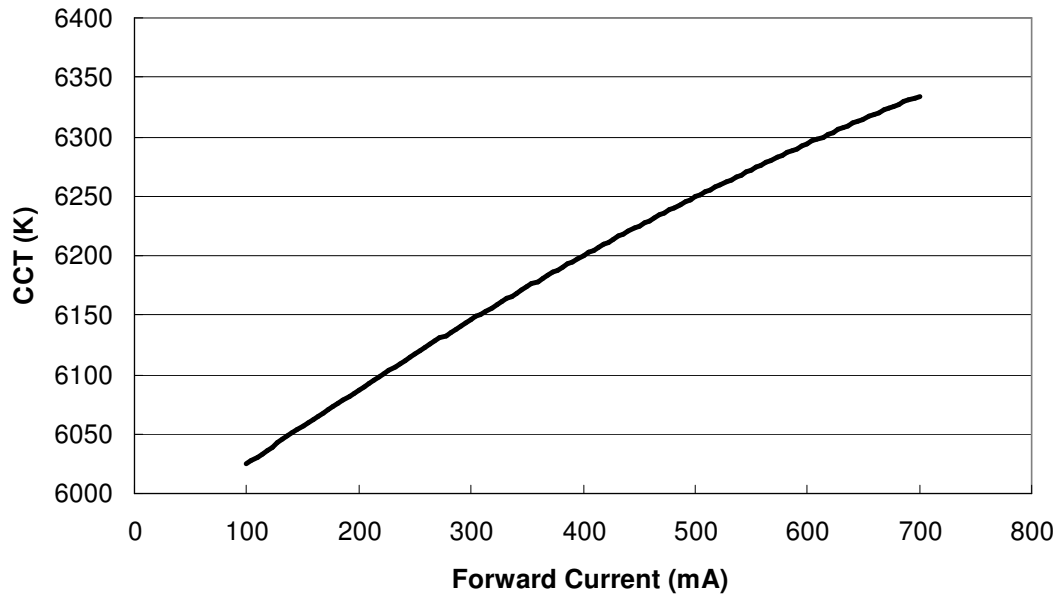

Figure 15: CCT vs. forward current for Cool White.

**Typical CCT Shift Characteristic for Cool White**

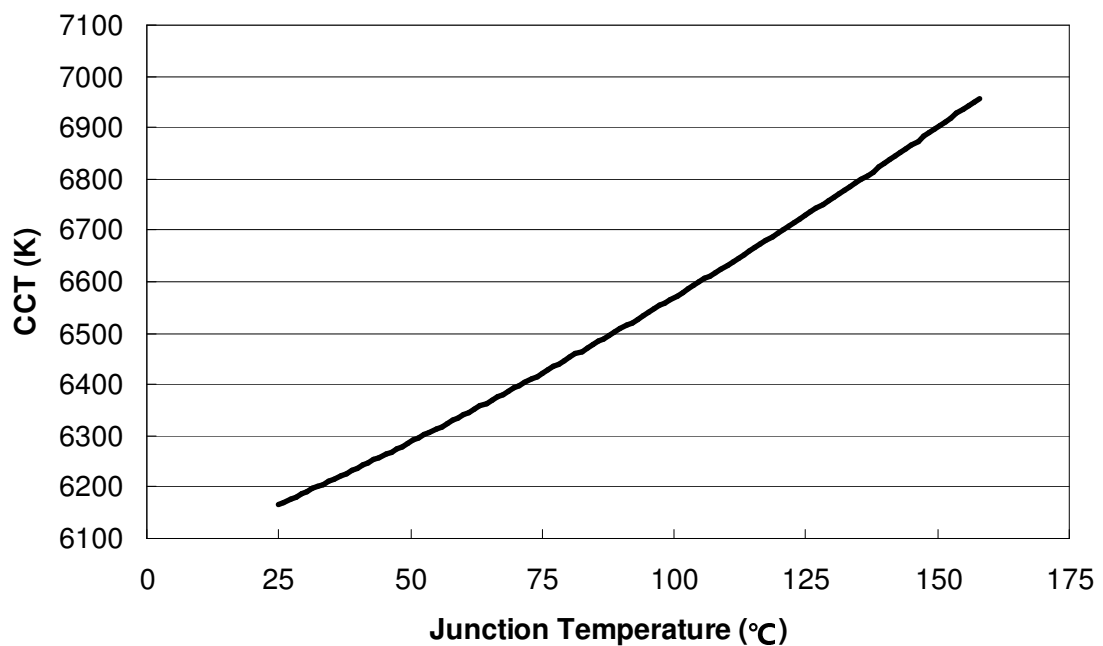

Figure 16: Typical CCT vs. junction temperature for Cool White.

**Typical Light Output Characteristics over Thermal Pad Temperature for Cool White**

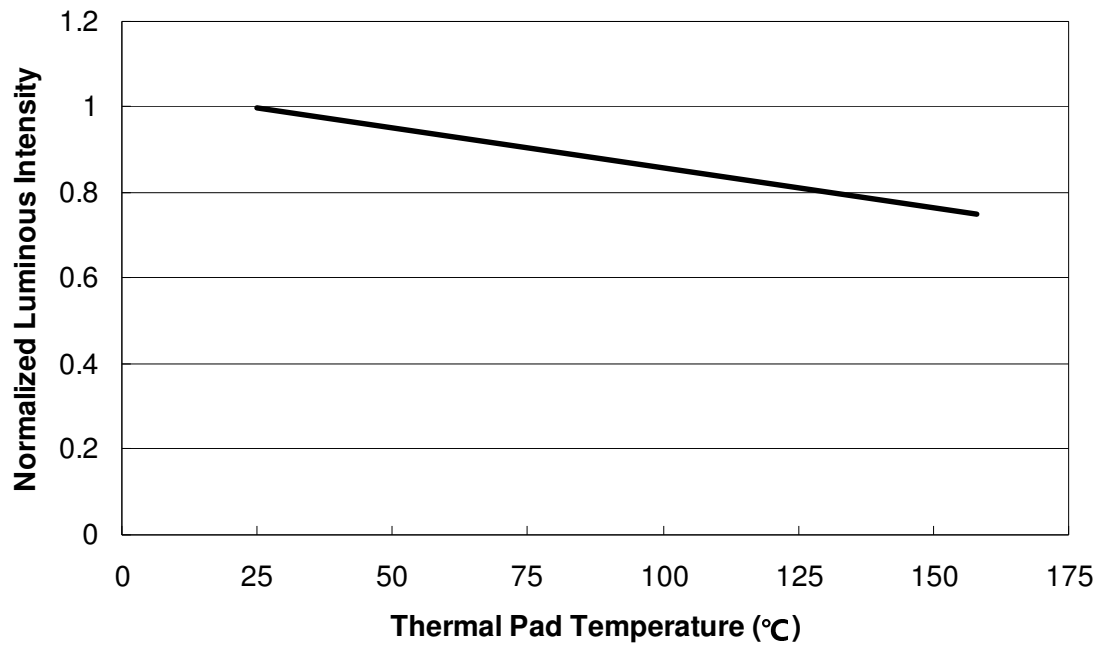

Figure 17: Relative luminous flux vs. thermal pad temperature for Cool White.

**Typical Light Output Characteristics over Thermal Pad Temperature for True Green, Blue, Red and Amber**

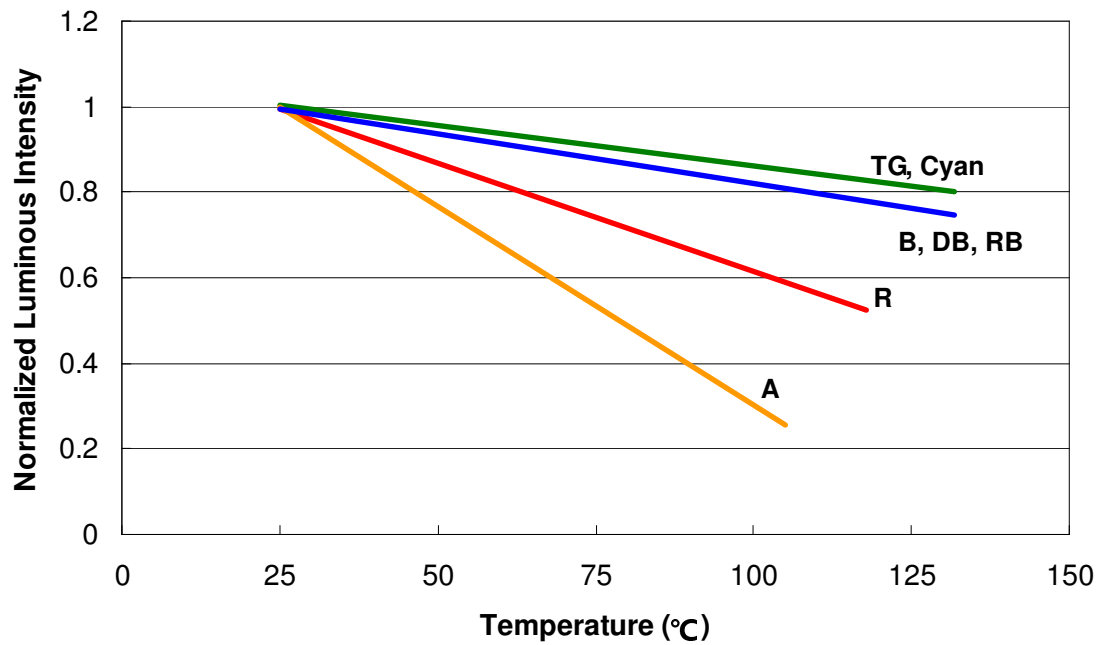

Figure 18: Relative luminous flux vs. thermal pad temperature for True Green, Blue, Red and Amber.

## Reflow Profile:

The following reflow profile is from IPC/JEDEC J-STD-020D which provided here for reference.

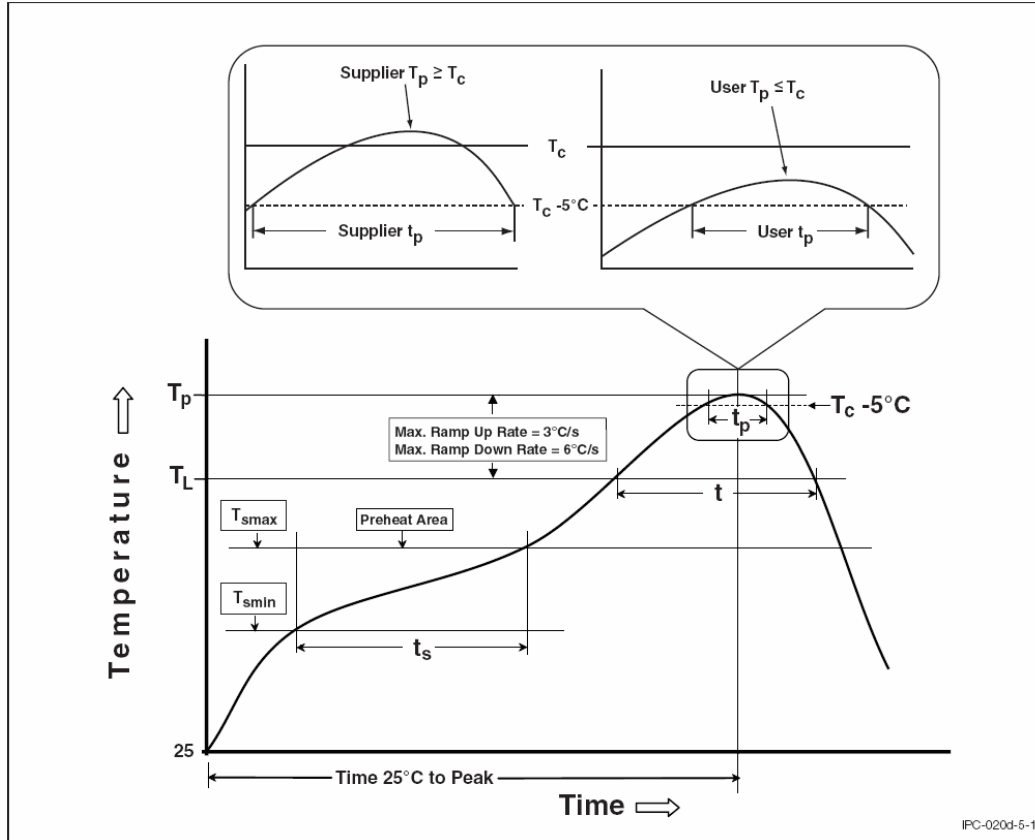
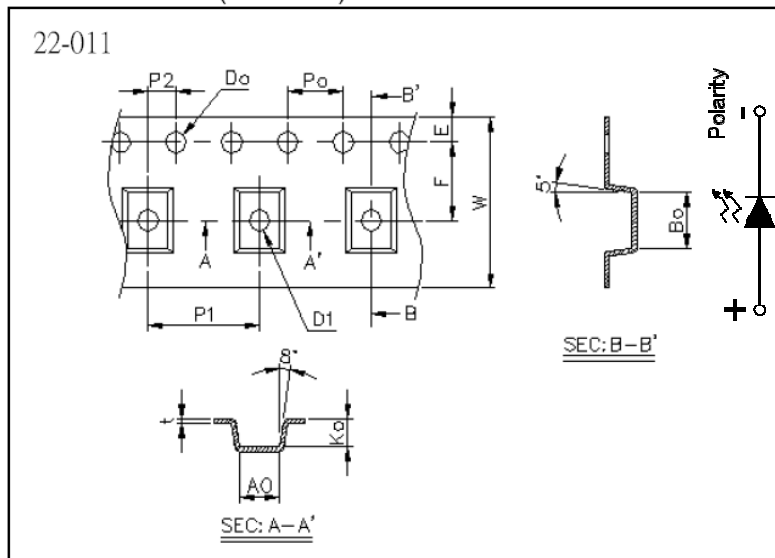

Table 11.

Profile Feature	Sn-Pb Eutectic Assembly	Pb-Free Assembly
<b>Preheat &amp; Soak</b>		
Temperature min ( $T_{smin}$ )	100 °C	150 °C
Temperature max ( $T_{smax}$ )	150 °C	200 °C
Time ( $T_{smin}$ to $T_{smax}$ ) ( $t_s$ )	60-120 seconds	60-120 seconds
Average ramp-up rate ( $T_{smax}$ to $T_p$ )	3 °C/second max.	3 °C/second max.
Liquidous temperature ( $T_L$ )	183 °C	217 °C
Time at liquidous ( $t$ )	60-150 seconds	60-150 seconds
Peak package body temperature ( $T_p$ )*	230 °C ~235 °C *	255 °C ~260 °C *
Classification temperature ( $T_c$ )	235 °C	260 °C
Time ( $t_p$ )** within 5 °C of the specified classification temperature ( $T_c$ )	20** seconds	30** seconds
Average ramp-down rate ( $T_p$ to $T_{smax}$ )	6 °C/second max.	6 °C/second max.
Time 25 °C to peak temperature	6 minutes max.	8 minutes max.
* Tolerance for peak profile temperature ( $T_p$ ) is defined as a supplier minimum and a user maximum.		
** Tolerance for time at peak profile temperature ( $t_p$ ) is defined as a supplier minimum and a user maximum.		

## Tape & Reel Packaging:

Dimensions. (Unit: mm)



Item	Specification	Tol. (+/-)
W	<b>12.00</b>	± 0.20
E	<b>1.75</b>	± 0.10
F	<b>5.50</b>	± 0.05
D0	<b>1.50</b>	+0.10, -0
D1	<b>1.50</b>	± 0.10
P0	<b>4.00</b>	± 0.05
P1	<b>8.00</b>	± 0.10
P2	<b>2.00</b>	± 0.05
P0 x 10	<b>40.00</b>	± 0.20

t	<b>0.25</b>	± 0.05
A0	<b>3.32</b>	± 0.10
B0	<b>4.87</b>	± 0.10
K0	<b>2.27</b>	± 0.10
A1		
B1		
K1		

Figure 19: Federal Reel Dimensions.

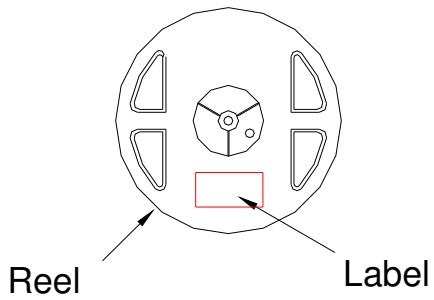

Item	Quantity	Total	Dimensions(mm)
Reel	250pcs	250pcs	Diameter=178
Inner box	4 reels	1,000pcs	240*235*67
Outer box	5 inner boxes	5,000pcs	353*254*256

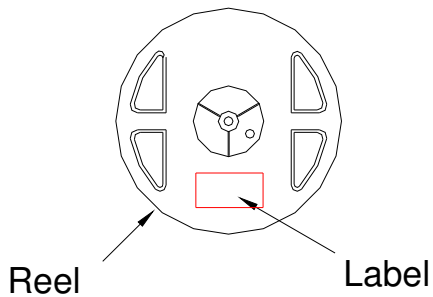

Item	Quantity	Total	Dimensions(mm)
Reel	1,000pcs	1,000pcs	Diameter=178
Inner box	5 reels	5,000pcs	240*235*67
Outer box	5 inner boxes	25,000pcs	353*254*256

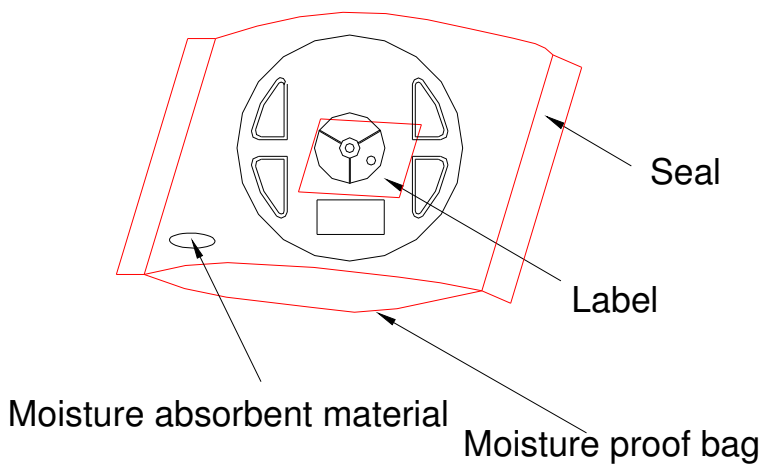

艾笛森光電股份有限公司 EDISON OPTO CORPORATION	
Part No : <u>    XX    </u>	Inspected By:
Group : <u>    XX    </u>	
Color : <u>    XX    </u>	
LOT NO. : <u>    XX    </u>	
Quantity : <u>    XX    </u>	
<b>A321000204</b> TEL:886-2-82276996 FAX:886-2-82276997 4F,No.800,Chung-Cheng Rd.,Chung-Ho City,Taipei,Taiwan.	

**Package Label**

## Edixeon® Federal Bin Groups

### Photometric Luminous Flux Bins for Cool White, Neutral White and Warm White

Table 12.

Group	Min. (lm)	Max. (lm)	Group	Min. (lm)	Max. (lm)
A	0.1	1.0	R	39.4	51.2
B	1.0	1.3	S1	51.2	58.8
C	1.3	1.7	S2	58.8	66.5
D	1.7	2.2	T1	66.5	70.0
E	2.2	2.9	T2	70.0	80.0
F	2.9	3.7	T3	80.0	86.5
G	3.7	4.8	U1	86.5	90
H	4.8	6.3	U2	90	100
J	6.3	8.2	U3	100	112.5
K	8.2	10.6	V	112.5	146.2
L	10.6	13.8	W	146.2	190.0
M	13.8	17.9	X	190.0	247.1
N	17.9	23.3	Y	247.1	321.2
P	23.3	30.3	Z	321.2	417.5
Q	30.3	39.4			

## Photometric Luminous Flux Bins for Single Colors

Table 13.

Group	Min. (lm)	Max. (lm)	Group	Min. (lm)	Max. (lm)
A	0.1	1.0	N	17.9	23.3
B	1.0	1.3	P	23.3	30.3
C	1.3	1.7	Q	30.3	39.4
D	1.7	2.2	R	39.4	51.2
E	2.2	2.9	S	51.2	66.5
F	2.9	3.7	T	66.5	86.5
G	3.7	4.8	U	86.5	112.5
H	4.8	6.3	V	112.5	146.2
J	6.3	8.2	W	146.2	190.0
K	8.2	10.6	X	190.0	247.1
L	10.6	13.8	Y	247.1	321.2
M	13.8	17.9	Z	321.2	417.5

## Radiometric Power Bins (mW)

Table 14.

Group	Min.	Max.	Group	Min.	Max.
A	10.0	15.0	K	384.4	576.7
B	15.0	22.5	L	576.7	865.0
C	22.5	33.8	M	865.0	1,298
D	33.8	50.6	N	1,298	1,946
E	50.6	75.9	P	1,946	2,919
F	75.9	113.9	Q	2,919	4,379
G	113.9	170.9	R	4,379	6,569
H	170.9	256.3	S	6,569	9,853
J	256.3	384.4	T	9,853	14,779



### Cool White X,Y Groups

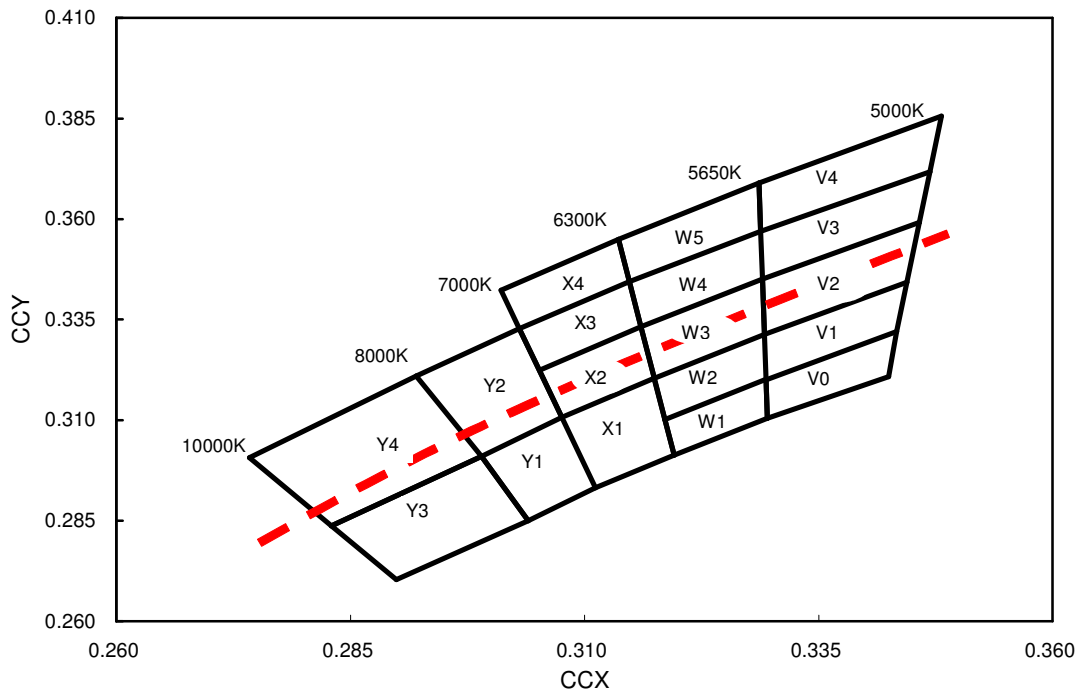

Figure 20: Cool White bin structure. The red line represents the blackbody locus on CIE 1931 graph.

**Note:**

**Edison maintains a tolerance of  $\pm 0.005$  on x, y color coordinates.**

## Cool White Edixeon® Federal X, Y Coordinates

**Table 15.**

Group/ CCT(Typ)	X	Y	Group/ CCT(Typ)	X	Y	Group/ CCT(Typ)	X	Y	Group/ CCT(Typ)	X	Y
V0 5300K	0.34335	0.33203	W1 6000K	0.32939	0.32021	X1 6650K	0.30755	0.31078	Y1 7500K	0.30400	0.28500
	0.34250	0.32080		0.32954	0.31050		0.31745	0.32044		0.29900	0.30100
	0.32954	0.31050		0.31960	0.30130		0.31960	0.30130		0.30755	0.31078
	0.32939	0.32002		0.31861	0.31020		0.31116	0.29319		0.31116	0.29319
V1 5300K	0.32922	0.33133	W2 6000K	0.32922	0.33133	X2 6650K	0.30755	0.31078	Y2 7500K	0.29900	0.30100
	0.34444	0.34423		0.32939	0.32021		0.30517	0.32239		0.29200	0.32100
	0.34335	0.33203		0.31861	0.31020		0.31604	0.33322		0.30305	0.33271
	0.32939	0.32002		0.31747	0.32044		0.31747	0.32044		0.30755	0.31078
V2 5300K	0.32922	0.33133	W3 6000K	0.32901	0.34509	X3 6650K	0.30517	0.32239	Y3 9000K	0.30400	0.28500
	0.32901	0.34509		0.32922	0.33133		0.30305	0.33271		0.28992	0.27032
	0.34578	0.35919		0.31747	0.32044		0.31479	0.34444		0.28297	0.28377
	0.34444	0.34423		0.31604	0.33322		0.31604	0.33322		0.29900	0.30100
V3 5300K	0.32901	0.34509	W4 6000K	0.32901	0.34509	X4 6650K	0.30305	0.33271	Y4 9000K	0.29200	0.32100
	0.32882	0.35692		0.31604	0.33322		0.30109	0.34224		0.27424	0.30067
	0.34690	0.37174		0.31479	0.34444		0.31362	0.35499		0.28297	0.28377
	0.34578	0.35919		0.32882	0.35692		0.31479	0.34444		0.29900	0.30100
V4 5300K	0.32882	0.35692	W5 6000K	0.31479	0.34444						
	0.32864	0.36895		0.31362	0.35499						
	0.34815	0.38563		0.32864	0.36895						
	0.34690	0.37174		0.32882	0.35692						

## Neutral White X,Y Groups

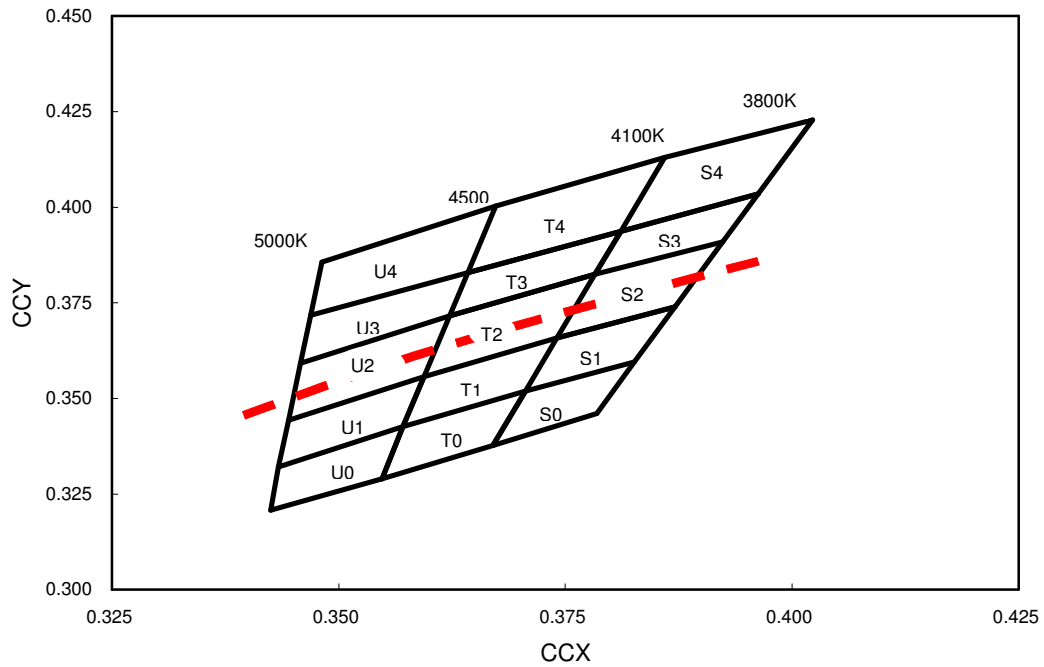

Figure 21: Neutral White bin structure. The red line represents the blackbody locus on CIE 1931 graph.

**Note:**

**Edison maintains a tolerance of  $\pm 0.005$  on x, y color coordinates.**

## Neutral White Edixeon® Federal X, Y Coordinates

Table 16.

Group/ CCT(Typ)	X	Y	Group/ CCT(Typ)	X	Y	Group/ CCT(Typ)	X	Y
S0  3900K	0.382598	0.359515	T0  4300K	0.370582	0.351953	U0  4750K	0.357079	0.342581
	0.378500	0.346000		0.367000	0.337700		0.354800	0.329000
	0.367000	0.337700		0.354800	0.329000		0.342500	0.320800
	0.370582	0.351953		0.357079	0.342581		0.343352	0.332034
S1  3900K	0.374075	0.365822	T1  4300K	0.359401	0.355699	U1  4750K	0.344443	0.344232
	0.387071	0.373899		0.357079	0.342581		0.343352	0.332034
	0.382598	0.359515		0.370582	0.351953		0.357079	0.342581
	0.370582	0.351953		0.374075	0.365822		0.359401	0.355699
S2  3900K	0.378264	0.382458	T2  4300K	0.362219	0.371616	U2  4750K	0.362219	0.371616
	0.392368	0.390932		0.378264	0.382458		0.359401	0.355699
	0.387071	0.373899		0.374075	0.365822		0.344443	0.344232
	0.374075	0.365822		0.359401	0.355699		0.345781	0.359190
S3  3900K	0.378264	0.382458	T3  4300K	0.364212	0.382878	U3  4750K	0.364212	0.382878
	0.381106	0.393747		0.381106	0.393747		0.362219	0.371616
	0.396279	0.403508		0.378264	0.382458		0.345781	0.359190
	0.392368	0.390932		0.362219	0.371616		0.346904	0.371742
S4  3900K	0.385953	0.412995	T4  4300K	0.367294	0.400290	U4  4750K	0.364212	0.382878
	0.402270	0.422776		0.385953	0.412995		0.367294	0.400290
	0.396279	0.403508		0.381106	0.393747		0.348147	0.385629
	0.381106	0.393747		0.364212	0.382878		0.346904	0.371742

## Warm White X,Y Groups

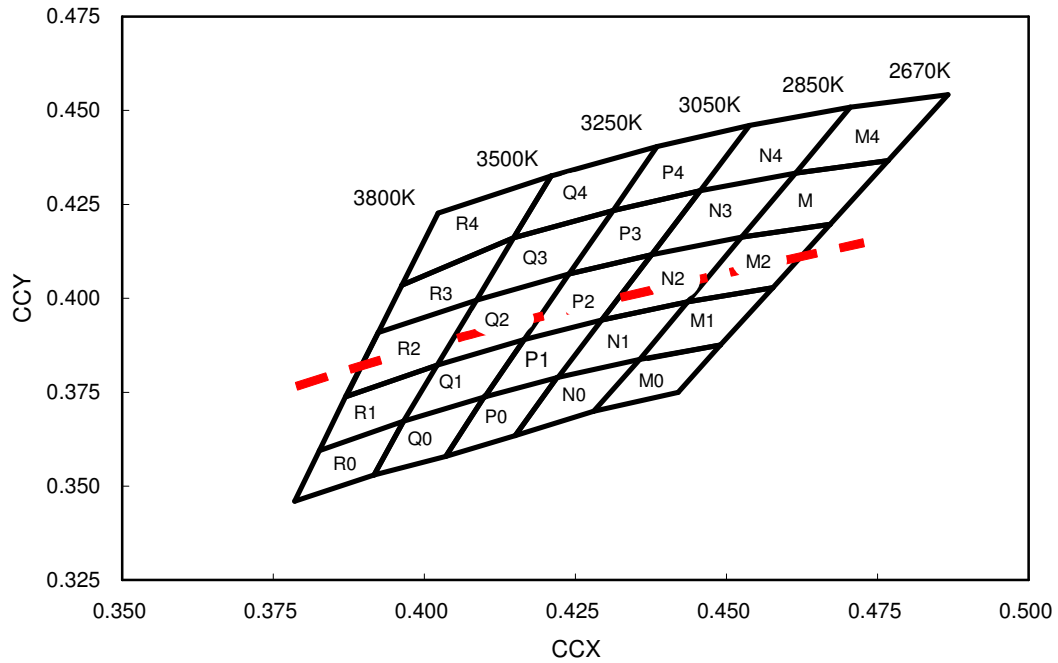

Figure 22: Warm White bin structure. The red line represents the blackbody locus on CIE 1931 graph.

**Note:**

**Edison maintains a tolerance of  $\pm 0.005$  on x, y color coordinates.**

## Warm White Edixeon® Federal X, Y Coordinates

Table 17.

Group/ CCT(Typ)	X	Y	Group/ CCT(Typ)	X	Y	Group/ CCT(Typ)	X	Y
M0	0.43700	0.38400	N0	0.43559	0.38371	P0	0.42200	0.37900
	0.44899	0.38752		0.42800	0.37000		0.41500	0.36350
2700K	0.44200	0.37500	2900K	0.41500	0.36350	3150K	0.40350	0.35800
	0.42800	0.37000		0.42200	0.37900		0.41000	0.37400
M1	0.44360	0.39911	N1	0.42937	0.39428	P1	0.42937	0.39428
	0.45766	0.40287		0.44360	0.39911		0.42212	0.37895
2700K	0.44899	0.38752	2900K	0.43559	0.38371	3150K	0.41000	0.37381
	0.43559	0.38371		0.42212	0.37895		0.41649	0.38900
M2	0.45251	0.41624	N2	0.43758	0.41163	P2	0.42396	0.40647
	0.46713	0.41963		0.42937	0.39428		0.43758	0.41163
2700K	0.45766	0.40287	2900K	0.44360	0.39911	3150K	0.42937	0.39428
	0.44360	0.39911		0.45251	0.41624		0.41649	0.38900
M3	0.46140	0.43333	N3	0.46140	0.43333	P3	0.43119	0.42339
	0.47673	0.43663		0.45251	0.41624		0.44564	0.42868
2700K	0.46713	0.41963	2900K	0.43758	0.41163	3150K	0.43758	0.41163
	0.45251	0.41624		0.44564	0.42868		0.42396	0.40647
M4	0.47051	0.45083	N4	0.45382	0.44598	P4	0.43846	0.44040
	0.48665	0.45419		0.47051	0.45083		0.45382	0.44598
2700K	0.47673	0.43663	2900K	0.46140	0.43333	3150K	0.44564	0.42868
	0.46140	0.43333		0.44564	0.42868		0.43119	0.42339

**Forward Voltage Bins for White, True Green, Blue, Dental Blue, Royal Blue,  
Cyan and Ultraviolet**

Table 18.

$V_F (V)$	
<b>V 0 1</b>	2.8 — 3.1
<b>V 0 2</b>	3.1 — 3.4
<b>V 0 3</b>	3.4 — 3.7
<b>V 0 4</b>	3.7 — 4.0
<b>V 0 5</b>	4.0 — 4.3
<b>V 0 6</b>	4.3 — 4.6
<b>V 0 7</b>	4.6 — 4.9
<b>V 0 8</b>	4.9 — 5.2

**Forward Voltage Bins for Red, Amber, Deep Red and Cherry Red**

Table 19.

$V_F (V)$	
<b>V 0 1</b>	2.0 — 2.25
<b>V 0 2</b>	2.25 — 2.5
<b>V 0 3</b>	2.5 — 2.75
<b>V 0 4</b>	2.75 — 3.0
<b>V 0 5</b>	3.0 — 3.25

## Dominant/Peak Wavelength Bin Structure

Group	$\lambda_d$ (nm), $\lambda_p$ (nm)
<b><i>Ultraviolet<sup>[1]</sup></i></b>	<b>395 — 410</b>
<i>W</i>	395 — 400
<i>X</i>	400 — 405
<i>Y</i>	405 — 410
<b><i>Royal Blue<sup>[1]</sup></i></b>	<b>440 — 460</b>
<i>V</i>	440 — 445
<i>W</i>	445 — 450
<i>X</i>	450 — 455
<i>Y</i>	455 — 460
<b><i>Dental Blue<sup>[1]</sup></i></b>	<b>450 — 470</b>
<i>W</i>	450 — 455
<i>X</i>	455 — 460
<i>Y</i>	460 — 465
<i>Z</i>	465 — 470
<b><i>Blue</i></b>	<b>455 — 475</b>
<i>V</i>	455 — 460
<i>W</i>	460 — 465
<i>X</i>	465 — 470
<i>Y</i>	470 — 475
<b><i>True Green</i></b>	<b>515 — 535</b>
<i>V</i>	515 — 520
<i>W</i>	520 — 525
<i>X</i>	525 — 530
<i>Y</i>	530 — 535
<b><i>Amber</i></b>	<b>585 — 595</b>
<i>X</i>	585 — 588
<i>Y</i>	588 — 591
<i>Z</i>	591 — 595
<b><i>Red</i></b>	<b>620 — 630</b>
<i>X</i>	620 — 630
<b><i>Deep Red</i></b>	<b>650 — 670</b>
<b><i>Cherry Red</i></b>	<b>730 — 750</b>

**Notes:**

1. Wavelengths are stated as peak wavelength.



## Dominant Wavelength and CIE Coordinate

Table 20.

	Royal Blue	Wavelength/nm @ 350 mA			CIE color coordinates		
		Min. $\lambda_p$	Max. $\lambda_p$	Avg. $\lambda_p$	saturation	average x	average y
	<i>Royal Blue W</i>	440	445	442.5	99.6%	0.1645	0.0114
	<i>Royal Blue X</i>	445	450	447.5	99.6%	0.1597	0.0169
	<i>Royal Blue Y</i>	450	455	452.5	99.2%	0.1554	0.0226
	<i>Royal Blue Z</i>	455	460	457.5	98.7%	0.1500	0.0299
	Blue	Wavelength/nm @ 350 mA			CIE color coordinates		
		Min. $\lambda_d$	Max. $\lambda_d$	Avg. $\lambda_d$	saturation	average x	average y
	<i>Blue V</i>	455	460	457.5	98.7%	0.1500	0.0299
	<i>Blue W</i>	460	465	462.5	98.2%	0.1434	0.0396
	<i>Blue X</i>	465	470	467.5	96.8%	0.1367	0.0568
	<i>Blue Y</i>	470	475	472.5	95.8%	0.1263	0.0817
	Green	Wavelength/nm @ 350 mA			CIE color coordinates		
		Min. $\lambda_d$	Max. $\lambda_d$	Avg. $\lambda_d$	saturation	average x	average y
	<i>Green V</i>	515	520	517.5	73.0%	0.1307	0.6939
	<i>Green W</i>	520	525	522.5	75.0%	0.1538	0.7077
	<i>Green X</i>	525	530	527.5	80.0%	0.1744	0.7201
	<i>Green Y</i>	530	535	532.5	83.5%	0.2003	0.7181
	Amber	Wavelength/nm @ 350 mA			CIE color coordinates		
		Min. $\lambda_d$	Max. $\lambda_d$	Avg. $\lambda_d$	saturation	average x	average y
	<i>Amber X</i>	585	588	586.5	99.3%	0.5480	0.4490
	<i>Amber Y</i>	588	591	589.5	99.3%	0.5631	0.4339
	<i>Amber Z</i>	591	595	593.0	99.6%	0.5785	0.4195
	Red	Wavelength/nm @ 350 mA			CIE color coordinates		
		Min. $\lambda_d$	Max. $\lambda_d$	Avg. $\lambda_d$	saturation	average x	average y
	<i>Red</i>	620	630	625	99.8%	0.7011	0.2982