

Infrared Assemblies

Wide Gap Transmissive Sensor

HOA1888 Series

FEATURES

- Choice of phototransistor or photodarlington output
- Visible ambient light and dust protective filter
- 12 mm (0.47 in.) slot width
- Snap-in housing

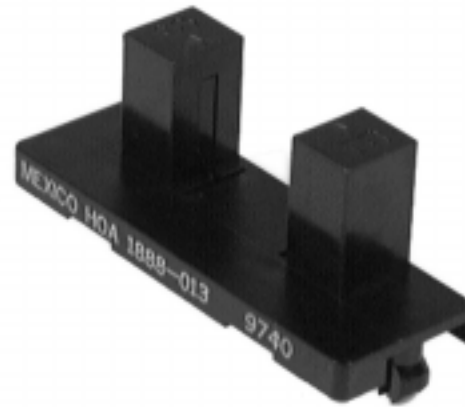

The HOA1888 Series consists of an infrared emitting diode facing an NPN silicon phototransistor (HOA1888-011) or photodarlington (HOA1888-013) encased in a black thermoplastic housing. Detector switching takes place whenever an opaque object passes through the slot between emitter and detector. Both emitter and detector have 1,52 mm (0.060 in.) x 1,52 mm (0.060 in.) vertical apertures.

The sensor housing contains IR (Infrared) transmissive optical windows. This arrangement provides excellent protection against visible ambient light while eliminating aperture openings which could be clogged by airborne contaminants.

Housing material is polycarbonate. Housings are soluble in chlorinated hydrocarbons and ketones. Recommended cleaning agents are methanol and isopropanol.

Infrared Assemblies

Wide Gap Transmissive Sensor

HOA1888 Series

ABSOLUTE MAXIMUM RATINGS (25°C free-air temperature unless otherwise noted)

Operating Temperature Range	-40°C to 85°C
Storage Temperature Range	-40°C to 85°C
Soldering Temperature (5 sec)	240°C

IR EMITTER

Power Dissipation	100 mW ⁽¹⁾
Reverse Voltage	3 V
Continuous Forward Current	50 mA

DETECTOR	TRANSISTOR	DARLINGTON
Collector-Emitter Voltage	30 V	15 V
Emitter Collector Voltage	5 V	5 V
Power Dissipation	100 mW ⁽¹⁾	100 mW ⁽¹⁾
Collector DC Current	30 mA	30 mA

Note:

- Derate linearly at 0.78 mW/°C above 25°C.

CAUTION

STRESS DAMAGE

Functional operation of the device at or above "Absolute Maximum Ratings" for extended periods of time may affect reliability.

Failure to comply with these instructions may result in product damage.

ELECTRICAL CHARACTERISTICS (25°C unless otherwise noted)

Parameter	Symbol	Min	Typ	Max	Unit	Test Condition
IR EMITTER						
Forward Voltage	V_F			1.6	V	$I_F=20$ mA
Reverse Leakage Current	I_R			10	μA	$V_R=3$ V
DETECTOR						
Collector-Emitter Breakdown Voltage	$V_{(BR)CEO}$				V	$I_C=100$ μA
HOA1888-011		30				
HOA1888-013		15				
Emitter-Collector Breakdown Voltage	$V_{(BR)ECO}$	5.0			V	$I_E=100$ μA
Collector Dark Current	I_{CEO}				nA	$V_{CE}=10$ V $I_F=0$
HOA1888-011				100		
HOA1888-013				250		
COUPLED CHARACTERISTICS						
On-State Collector Current	$I_{C(ON)}$				mA	$V_{CE}=5$ V
HOA1888-011		0.5				$I_F=20$ mA
HOA1888-013		2.0				
Collector-Emitter Saturation Voltage	$V_{CE(SAT)}$				V	$I_F=20$ mA
HOA1888-011				0.4		$I_C=60$ μA
HOA1888-013				1.1		$I_C=250$ μA
Rise And Fall Time	t_r, t_f				μs	$V_{CC}=5$ V, $I_C=1$ mA
HOA1888-011			15			$R_L=1000$ Ω
HOA1888-013			75			$R_L=100$ Ω

Infrared Assemblies

Wide Gap Transmissive Sensor

HOA1888 Series

SCHEMATIC

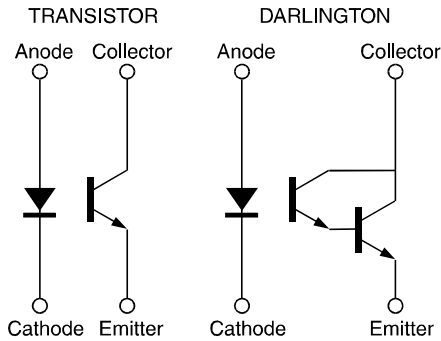

Figure 1: IRED Forward Bias Characteristics

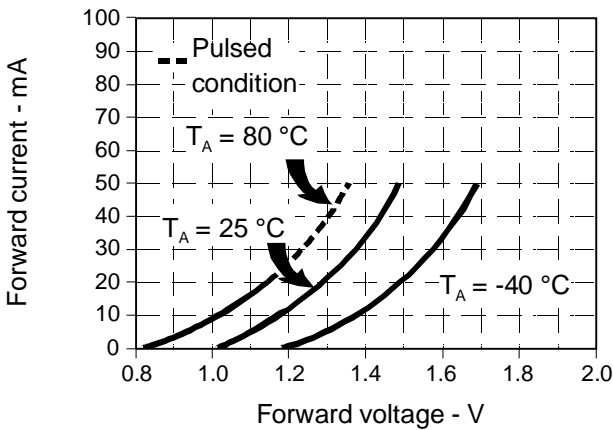

Figure 3: Detector Dark Current vs Temperature

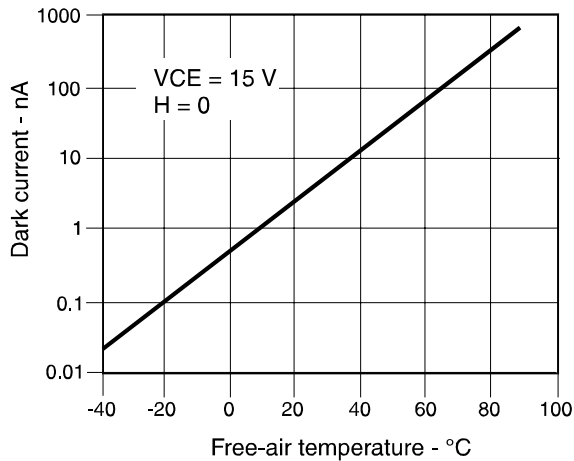

Figure 2: Non-saturated Switching Time vs Load Resistance

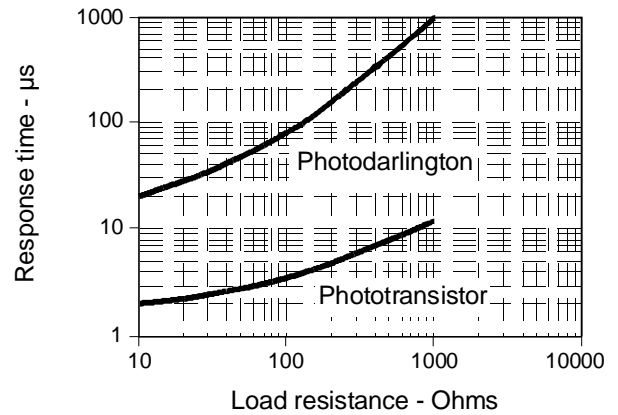
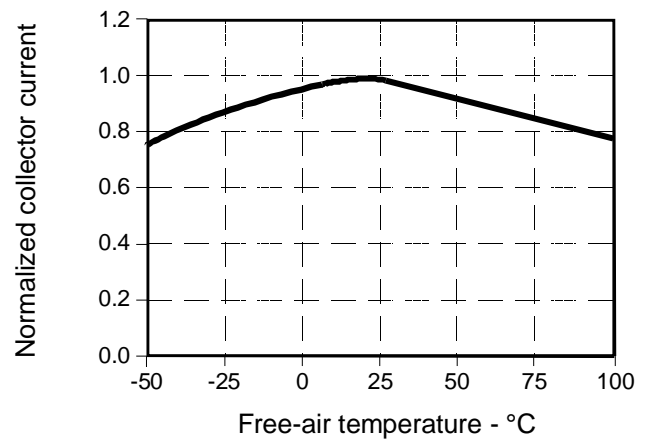

Figure 4: Collector Current vs Ambient Temperature



Infrared Assemblies

Wide Gap Transmissive Sensor

HOA1888 Series

ORDER GUIDE

Catalog Listing	Description
HOA1888-011	Wide Gap Transmissive Sensor, Phototransistor
HOA1888-013	Wide Gap Transmissive Sensor, Photodarlington

OUTLINE DIMENSIONS mm (in.) (for reference only)

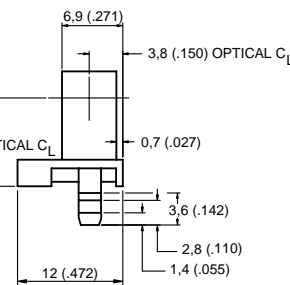
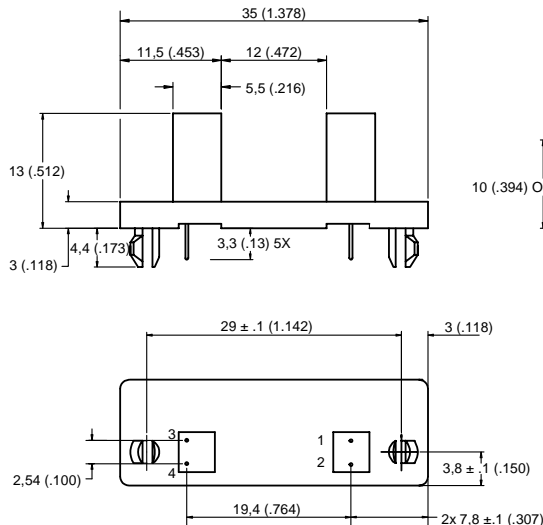

LEADS:
 1. ANODE 3. EMITTER
 2. CATHODE 4. COLLECTOR

RECOMMENDED PCB MOUNTING HOLE DIMENSIONS mm (in.)

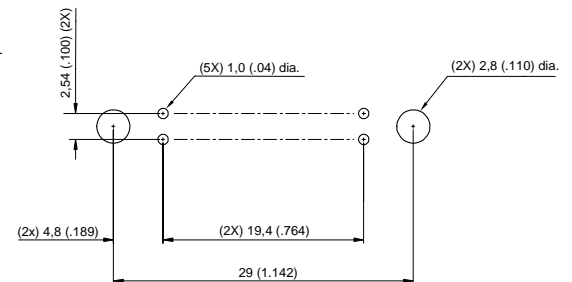

WARRANTY/REMEDY

Honeywell warrants goods of its manufacture as being free of defective material and faulty workmanship. Contact your local sales office for warranty information. If warranted goods are returned to Honeywell during that period of coverage, Honeywell will repair or replace without charge those items it finds defective. The foregoing is Buyer's sole remedy and is **in lieu of all other warranties, expressed or implied, including those of merchantability and fitness for a particular purpose.**

While we provide application assistance, personally, through our literature, and through the Honeywell website, it is up to the customer to determine the suitability of the product in the application.

Specifications may change at any time without notice. The information we supply is believed to be accurate and reliable as of this printing. However, we assume no responsibility for its use.

SALES AND SERVICE

MICRO SWITCH Sensing and Control serves its customers through a worldwide network of sales offices and distributors. For application assistance, current specifications, pricing or name of the nearest Authorized Distributor, contact a nearby sales office or call:

TELEPHONE

1-800-537-6945 (USA)
 1-800-737-3360 (Canada)
 1-815-235-6847 (International)

FAX

1-815-235-6545 (USA)

INTERNET

www.honeywell.com/sensing
info@micro.honeywell.com

Honeywell

Sensing and Control
 Honeywell Inc.
 11 West Spring Street
 Freeport, Illinois 61032

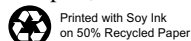

Printed with Soy Ink
 on 50% Recycled Paper

www.honeywell.com/sensing