

GENERAL INFORMATION FOR MQ SERIES GAS SENSORS

1. Initial action

When the semi-conductor gas sensor is energized after a period without energizing, The sensor resistance (R_s) drops sharply for a few seconds after energizing, regardless of the presence of gases, and then tends to reach a stable level according to the ambient atmosphere, Such process is called “Initial Action”. The time of “Initial Action” is relevant to sensor variety, stored time, storage environment. Generally the longer time you stored it, the more time are needed to resumed, but the resumed time won't be more than 5 minutes. The figure.1 shows the initial action of the sensor resistance (R_s) for a sensor which stored unenergized in normal air for different times.

A represents 15days stored, B represents 1 day stored, C represents 2 hours stored

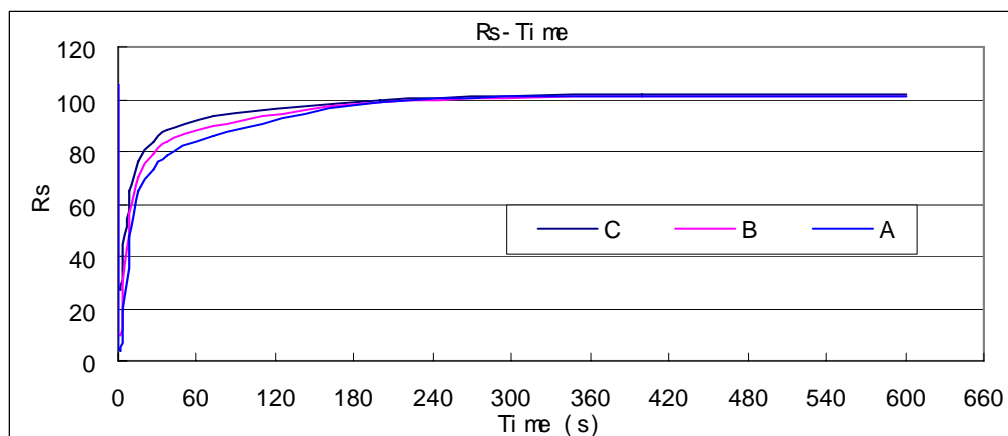

Fig.1

Notice that if the unpowered storage period becomes longer, a longer preheating period more than 24 hours is required to stabilize the sensor before usage.

Since this “initial action” may cause a detector to alarm unnecessarily during the initial moments after powering on, when using MQ series gas sensor, it is recommended that an initial delay circuit be incorporated into the detector's design, This is especially recommended is very necessary for intermittent-operating devices such as portable gas detectors .

2. Sensitivity to gas

All the semi-conductor sensor has different sensitivity according to different gases. The relationship between sensor resistance and the concentration of deoxidizing gas can be expressed by the following equation over a certain range of gas concentration:

$$R = nC^{-m} \quad (\log(R_s) = m \log C + n)$$

where: R = electrical resistance of the sensor

C = gas concentration

m, n = constant

m represents the sensitivity according to the change of gas concentration ,

n is relevant to sensitivity to the detected gas, concomitancing the difference with different sensors ,gas variety ,and detecting terms .

According to the above formula, the relationship of sensor resistance to gas concentration is linear on a logarithmic scale within a practical range of gas concentration (from several ppm to several thousand ppm). Figure.2 shows a typical example of the relationship between sensor resistance and gas concentration. The sensor will show sensitivity to a variety of deoxidizing gases, with relative sensitivity to certain gases optimized by the formulation of sensing materials and operating temperature. Since actual sensor resistance values vary from sensor to sensor, typical sensitivity characteristics are expressed as a ratio of sensor resistance in various concentrations of gases (R_s) over resistance in a certain concentration of a target gas (R_o). Sensor resistance varies as a logarithmic function of gas concentration, Sensitivity characteristics to a certain gas differs with sensor type. When measuring a certain gas, possible interference of co-existing gases must always be taken into consideration, For example, when measuring an atmosphere containing both Methane and Ethanol, the Methane measurement can be affected by the Ethanol.

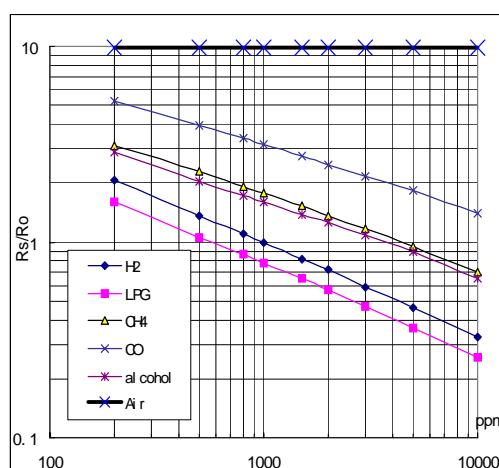

Fig.2

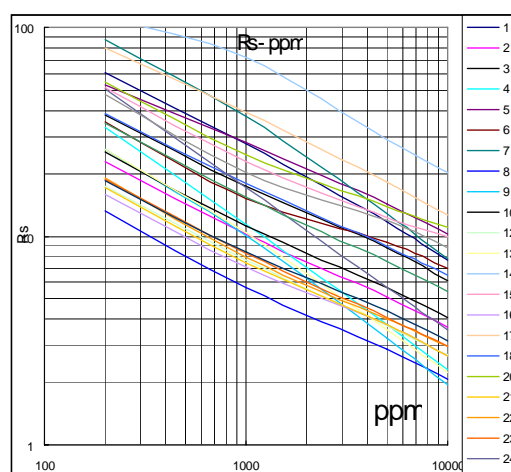

Fig.3

As the influence of manufacturing principle and handicraft, the sensor has some decentralization, although it is one common formula, since the R_s of sensor distributing in a larger range, Resistance value of the same sensor is different to various kinds and various concentration gases, Resistance value of various sensor has difference to the same gas concentration too, as Figure 3. When supplying productions, sensors are always selected in different range of R_s , Although it still has certain decentralization in a smaller range. So, When using this components, sensitivity adjustment and calibration is very necessary to every sensor.

In addition, When accurately measuring, the proper alarm point for the gas detector should be determined after considering the temperature and humidity influence.

3. Temperature and humidity Dependency

The sensing principle of semi-conductor sensor is based on chemical adsorption and desorption of gases on the sensor's surface, the ambient temperature and humidity will affect sensitivity characteristics easily. According to the above, A compensation circuit for temperature dependency must be considered when using MQ series sensor in the application of better precision and reliability .

Figure 4 shows a typical example of these dependencies.

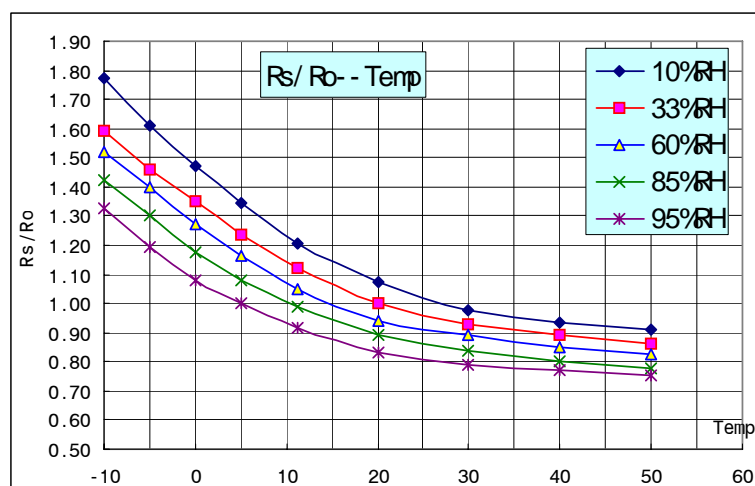

Figure 5 shows the compensation circuit with thermistors (R_t) for temperature. (compensation of checking the data sheet with MCU also recommended).

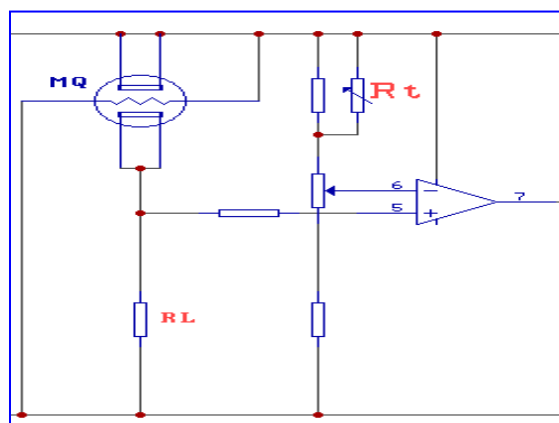

Fig.5

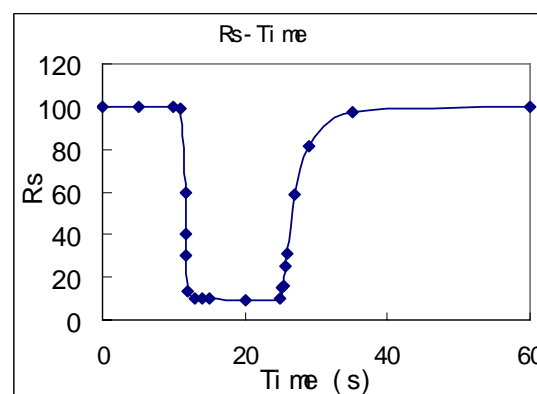

Fig. 6 - Typical sensor response

4. Sensor response

Figure 6 demonstrates typical behavior when the sensor is exposed to and then removed from a deoxidizing gas. Sensor resistance will drop very quickly when exposed to gas, and when removed from gas its resistance will recover to its original value after a short time. The speed of response and reversibility will vary according to the model of sensor and the gas involved.

5. Long-term stability

Figure 7 shows long-term stability of MQ-2 as measured for more than 6 years. The sensor is first energized in normal air. Measurement for confirming sensor characteristics is conducted under ambient air conditions rather than in a temperature/ humidity controlled environment. The cyclic change in sensitivity corresponds to the seasonal changes of temperature/humidity.

During these measurements, the gas sensors are powered in a clean atmosphere and then exposed to a gas at certain intervals. It should be noted that sensors will not function normally when continuously exposed to a certain concentration of gas.

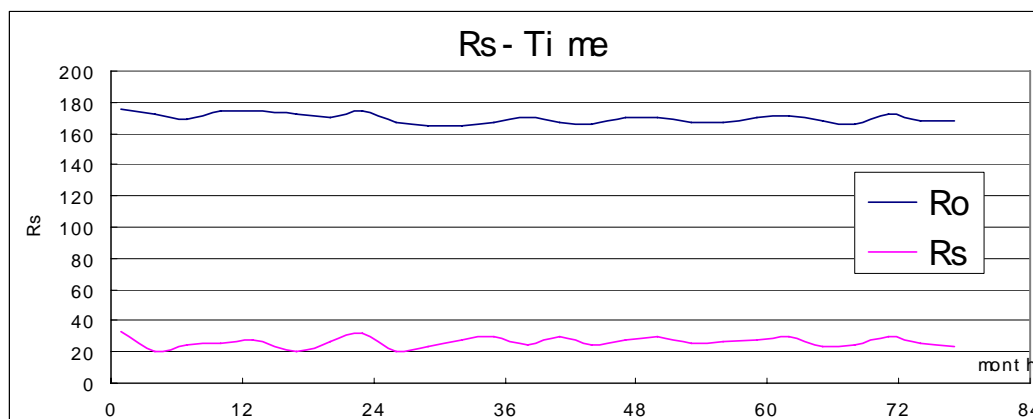

Fig.7

6. Oxygen concentration

MQ gas sensors are used in an oxygen concentration atmosphere of approximately 21%. If you intend to use MQ gas sensors under different conditions, please consult us.

Notes

Cautions on Usage of MQ series Gas Sensors

Situations which must be avoided

1) Exposure to silicone vapors

If silicone vapors adsorb onto the sensor's surface, the sensing material will be coated, irreversibly inhibiting sensitivity. Avoid exposure where silicone adhesives, hair grooming materials, or silicone rubber/putty may be present.

2) Highly corrosive environment

High density exposure to corrosive materials such as H₂S, SO_x, Cl₂, HCl, etc. for extended periods may cause corrosion or breakage of the lead wires or heater material.

3) Contamination by alkaline metals

Sensor drift may occur when the sensor is contaminated by alkaline metals, especially salt water spray. This may also happen if the sensor is exposed to inorganic elements.

4) Contact with water

Sensor drift may occur due to soaking or splashing the sensor with water.

5) Freezing

If water freezes on the sensing surface, the sensing material would crack, altering characteristics.

6) Application of excessive voltage

If higher than specified voltage is applied to the sensor or the heater, lead wires may be damaged or sensor characteristics may drift, even if no physical damage or breakage occurs.

7) Application of voltage on lead wires

On six-pin type sensors, if a voltage is applied on the lead wires between pins A and A and/or pins B and B, this would cause breakage of the lead wires.

Situations to be avoided whenever possible

1) Water condensation

Light condensation under conditions of indoor usage should not pose a problem for sensor performance. However, if water condenses on the sensor's surface and remains for an

extended period, sensor characteristics may drift.

2) Usage in high density of gas

Sensor performance may be affected if exposed to a high density of gas for a long period of time, regardless of the powering condition.

3) Storage for extended periods

When stored without powering for a long period, the sensor may show a reversible drift in resistance according to the environment in which it was stored. The sensor should be stored in a sealed bag containing clean air; do not use silica gel. Note that as unpowered storage becomes longer, a longer preheating period is required to stabilize the sensor before usage.

4) Long term exposure in adverse environment

Regardless of powering condition, if the sensor is exposed in extreme conditions such as very high humidity, extreme temperatures, or high contamination levels for a long period of time, sensor performance will be adversely affected.

5) Vibration and Shock

Excessive vibration may cause the sensor or lead wires to resonate and break. Usage of compressed air drivers on assembly lines may generate such vibration. Breakage of lead wires may occur if the sensor is subjected to a strong shock.

6) Soldering flux

Sensors should be soldered manually. Wave soldering or automatic soldering mechanisms may generate large amounts of flux vapors which may cause a drift in sensor performance which is similar to the effect of silicone vapors.